

User Manual

Perrot Satellite



Table of Contents

0 FOREWORD	6
0.1 Introduction	6
0.2 Basic Instructions for Using this Manual.....	7
1 FUNCTION DESCRIPTION.....	8
1.1 How the Irrigation System Works	8
1.2 Actuators	8
1.3 Logics / Control.....	8
1.4 Sensors	9
2 VCU AND DECODER INSTALLATION	10
2.1 Hardware Installation and Master VCU Powering	10
2.2 VCU's Power Supply and Grounding	10
2.3 Networking of Satellites to Master VCU	12
2.4 VCU Wiring Diagram	14
2.5 Decoder Wiring Diagram	15
3 SOFTWARE INSTALLATION.....	18
3.1 Preparation of PC for installation of Perrot Satellite.....	18
3.2 Requirements on PC and operating system	18
3.3 Order of installation	19
3.3.1 SQL-Server	19
3.3.2 IIS (Internet Information Service)	23
3.3.3 Perrot Satellite.....	24
3.3.4 WebSatellite	28
3.3.5 Setting up Internet Explorer.....	32
3.3.6 Troubleshooting	34
3.3.7 Language Setup.....	34
3.4 Checking the Communication between PC, Master VCU & Satellites	36
3.5 Uploading the VCU Software.....	38
4 WORKING WITH PERROT SATELLITE	41
4.1 Starting Perrot Satellite	41
4.2 Starting Satellite Browser (user interface program)	43
4.3 Creating a User.....	45
4.4 Overview of Technician, Super-user and User Rights	46
4.5 Explanation of Screen Sections.....	47

5 ENTERING THE BASIC DATA	49
5.1 Structuring a Project.....	49
5.2 Entering the Irrigation Parameters	52
5.2.1 Irrigation Process	52
5.2.2 What Data Do I Need for the Program?	52
5.2.3 Irrigated Area Example.....	53
5.2.4 Activation of Hydraulic Groups and Sectors	54
5.3 Dividing the Area into Courses	55
5.4 Creating Satellites	57
5.5 Creating Pump Data	60
5.6 Hydraulic Groups and Sectors.....	65
5.7 Selection Names	68
5.8 Valve Data	70
 ons (Pump Management)	74
5.9.1 Switching Pumps On/Off by Program Start/End.....	74
5.9.2 Pump Control by Irrigation Programs	76
6 IRRIGATION PROGRAMS	78
6.1 Description of Different Program Types	78
6.1.1 Valves (individual valves)	78
6.1.2 Valve Collections.....	78
6.1.3 Manual Program.....	78
6.2 Creating Irrigation programs.....	79
6.2.1 Programming Individual Valves.....	80
6.2.2 Programming Valve Collections	80
6.2.3 Operator-Controlled Program Operation	80
6.3 "Valve" Irrigation Program	81
6.3.1 Creating a New Irrigation Program (from scratch).....	82
6.3.2 Making a Copy of an Existing Program (Saving it under a Different Name).....	85
6.4 "Valve Collection" Irrigation Program.....	85
6.4.1 Creating Valve Collection Budgets.....	85
6.4.2 Creating a "Valve Collection" Irrigation Program.....	86
6.4.3 Creating a New Irrigation Program (from scratch).....	88
6.4.4 Making a Copy of an Existing Program (Saving it under a Different Name).....	89
6.5 "Manual" Irrigation Program	90
6.5.1 Procedure.....	90

6.5.2	Creating a New Irrigation Program (from scratch)	91
6.5.3	Making a Copy of an Existing Program (Saving it under a Different Name)	94
6.6	Creating Irrigation Schedule	95
6.7	Automatic Irrigation Procedure	98
6.8	Irrigation Status – Terminology Explanation	99
6.9	Manual Start of Irrigation Program	100
7	SENSORS AND OTHER EXTERNAL DEVICES	102
7.1	System Data and External Devices	102
7.1.1	Scale	103
7.1.2	Offset	104
7.2	Connecting a Rain Sensor	104
7.3	Connecting Sensors	108
7.3.1	Connecting a Flow Sensor	108
7.3.2	Connecting a Pressure Sensor	110
7.3.3	Connecting an Anemometer (Wind Sensor)	113
7.4	Irrigation Control by External Sensors/Devices	115
7.4.1	External Sensors for a Weather Station	116
7.4.2	External Sensors for Device Monitoring (S5/S6)	118
7.5	Pump Monitoring for Errors	119
7.5.1	Setting the Pump Monitoring	119
7.5.2	Emergency Call in Case of Pump Error	122
8	GRAPHIC OVERVIEW	123
8.1	Description	123
8.2	Converting and Inserting a Graphic Image	124
8.2.1	Converting Graphic Files	124
8.2.2	Inserting a Graphic Image	126
8.3	Placing Valve Icons in Graphic Image	127
8.4	Manual Opening of Individual Valves	130
8.5	Displaying the Current Valve Status	131
8.6	User Information on Irrigation Process	132
9	REMOTE ACCESS FROM THE INTERNET	134
9.1	Description and Communication Diagram	134
9.2	Remote PC Hardware and Software Requirements	135
9.3	Perrot Satellite Remote Control over the Internet	135
9.4	Perrot Satellite Remote Control over from PDA	136
9.4.1	Establishing a Connection	136

9.4.2 Manual Valve Opening from PDA	136
9.5 Perrot Satellite Checklist for Internet Remote Access.....	140
10 TRANSMITTER.....	142
10.1 Remote control via the transmitter TM1	142
10.2 Remote control via Wireless Transmitter.....	143
11 REPORTS	144
11.1 Irrigation Reports	144
11.2 Irrigation Program Report	146
11.3 Yearly Report.....	147
11.4 Program/Valve Snapshot.....	149
12 DATA BACKUP	150
12.1 Backing up Your Data	150
12.1.1 Stopping <i>Perrot Satellite</i> software	150
12.1.2 Executing the Backup Function	151
12.1.3 Starting <i>Perrot Satellite</i> software	152
12.2 Restoring your Data	153
12.2.1 Stopping <i>Perrot Satellite</i> software	153
12.2.2 Executing the Restore Function	154
12.2.3 Starting <i>Perrot Satellite</i> software	155
13 DECODER.....	156
13.1 Decoder Programming.....	156
13.2 Programming Bidirectional Decoders	161
13.3 Decoder List	162
13.4 Variable current values at standard decoders type PD2-5/AC for Greenkeeper Win and for <i>Perrot Satellite</i>	163
14 FEEDBACK CONTROL	164
14.1 Feedback System	164
14.2 Setting up the Feedback System	166
14.2.1 Entering Data for Bidirectional Decoder and Pressure Sensor.....	166
14.2.2 Setting up Feedback	167
14.3 Error Handling in <i>Perrot Satellite</i> Feedback System.....	169
15 SERVICE MENU	171
15.1 Overview of Measured Values.....	171
15.2 Decoder Test	173
15.3 Viewing the Application Log	176

16 ERROR CODES.....177

0 Foreword

0.1 Introduction

Congratulations on purchasing the new **Perrot Satellite Software**. You have the most modern modular system which will accommodate any need you may have for the automatic control of all important irrigation functions.



Please read this manual carefully and follow all instructions specified in it. This manual will help you to understand the use and operation of the whole system and will present all important safety instructions..



For safety reasons neither children/young people under the age of 16 nor people who have not thoroughly acquainted themselves with this manual are allowed to operate the system.

➔ **Please keep this manual in a safe place!**

Should you have any questions concerning the programming or specific software functions, contact your authorised dealer or our customer service, which can be contacted at:

REGNERBAU CALW GmbH
Industriestraße 19-29
D-75382 Althengstett



Phone: +49-7051 / 162-0

Email: technik@perrot.de

Caution:

This documentation and the corresponding software must not be copied, transferred, modified or translated into additional languages without our prior written approval. It is allowed to make a safety copy for the user's personal needs.

This documentation and the corresponding software have been created in line with the current state of technology development. Perrot Regnerbau Calw GmbH can be held liable for subsequent damages caused directly or indirectly in association with using this documentation only if serious negligence or malice is proven.

We reserve the right to modify this documentation as well as the hardware and/or the software. All trade marks mentioned in this documentation are the property of their owners – even if not explicitly specified.

0.2 Basic Instructions for Using this Manual

This manual has been designed for both beginners and advanced users. This is why we will introduce the operating of the system step by step.

First we will introduce the basic terminology and definitions, and then one sample system on which we will explain how to set up the system and enter data.

Having all the necessary data and information, we will proceed to actual step by step programming and configuring of the system. During the process, you will become acquainted with all important points, which will make it easier to configure your irrigation based on your own values reflecting your particular needs.

In addition to these, you will pick up a lot of useful practical tips for working with the PERROT irrigation system.

The following information about the content is provided for advanced users. It specifies individual topics, explains terms and shows how particular topics can be easily found.

Symbols on the left point out useful information or warnings:



This highlights **information** which may be useful for you in the chapter.



This highlights **warnings**, i.e. important points you must pay attention to!

We will proceed the following way:

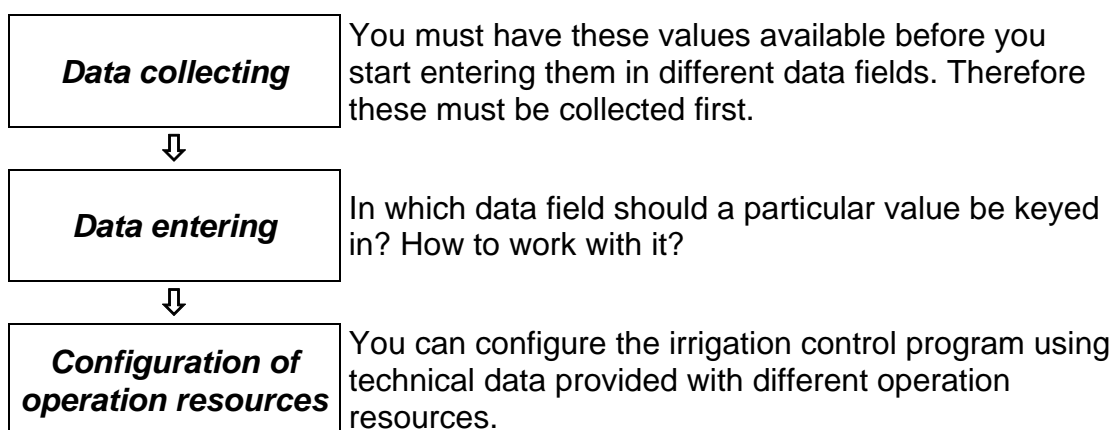

1 Function Description

1.1 How the Irrigation System Works

You need the following function groups to provide "rain to order":

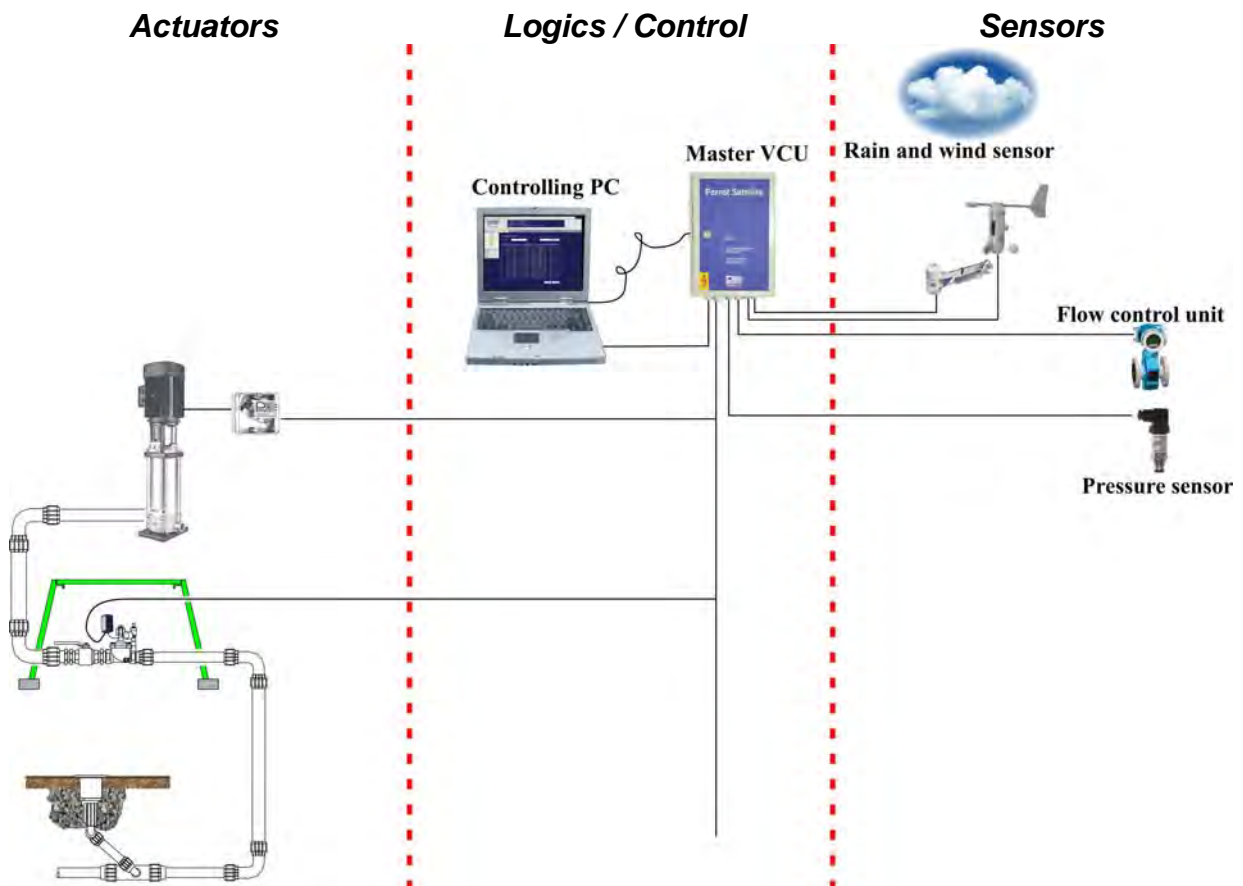

1.2 Actuators

In order to irrigate a lawn with a pop-up sprinkler, a pump must pump water to it through a pipeline. However, as not all sprinklers should start irrigating at the same time, there are valves installed between the pump and the sprinklers. The pump and the valve are interconnected with a control circuit through a decoder.

1.3 Logics / Control

All keyed in values, sensor-sent signals and the whole data management are logically processed. Different actions are calculated based on these processed data. The control system sends commands through valve control units (VCU) and through data lines to pump or valve decoders. In case of bidirectional decoders, it then receives answers (feedback) through the same system.

1.4 Sensors

The efficiency of all commands sent through the system is checked by pressure and flow-metering sensors. In case of an error being reported, it is possible to immediately trace back its cause.

In case of rain or strong wind, the rain/wind sensor sends the corresponding signal to the control system, which halts the planned irrigation.

2 VCU and Decoder Installation

2.1 Hardware Installation and Master VCU Powering

Site Preparation for the Master VCU Installation

- ✓ The Master VCU must be powered from a SCHUKO socket (=type F grounding contact) from which the grounding green/yellow wire must be disconnected. Grounding will be done through the Master VCU.
- ✓ Plug an adapter with over-voltage protection into the socket.
- ✓ Install the Master VCU at a suitable place on the wall.
Connect the decoder cable to terminals 34/35.
If you want to connect more cables (up to 3), use terminals 36/37 and 38/39 (see the wiring diagram in chapter 2.4).

Now connect additional external interfaces (such as the Mini Click rain sensor, for example) to the corresponding terminals.

2.2 VCU's Power Supply and Grounding

- ✓ Earth the unit with a grounding strip according to the diagram.
Place an at least 20m-long grounding strip in a trench at least 70 cm deep (see the diagram). The grounding resistance should be smaller than 10 Ohm. In case of poor conductivity soil (sand, sand-gravel), use 2 x 20 m conductors. Install a potential-balancing strip on the wall inside the building.
Connect the grounding strip to the potential-balancing strip.
Connect this strip to the VCU using a 1x16 mm² yellow/green cable.
Then connect a grounding cable to the grounding terminal in the VCU and to the potential-balancing strip.
Grounding equipment ordering code: SB50001.
- ✓ There are 2 Schuko sockets on the right side of the VCU. Connect your PC to one of them. If you have a monitor equipped with its own Schuko plug, connect it to the other socket. You can use any socket to connect a modem (if you want to use a modem).
- ✓ Plug the VCU power cable plug into the adapter with over-voltage protection, which is already plugged into the socket.
Connect the VCU to the COM 1 serial port of your PC.
If your PC features more than one serial port, use the one marked as Port 1, COM 1, Ser. 1, A or in a similar way.
- ✓ Turn the power on.
The VCU will confirm the connection with a beep.

The **green LED** on the VCU is **permanently on**.

The **yellow LED** blinks if:

- ☆ The Master VCU is communicating with the PC through the serial interface
- &
- ☆ *Perrot Satellite* has been started
- &
- ☆ The Master VCU is **NOT** in a passive state in the **Setup > Satellites** menu (see chapter 5.4).

The **red LED** must be **off**.

If the red LED is on, there is an error in the decoder cable.

Check all the decoder cables and connectors.

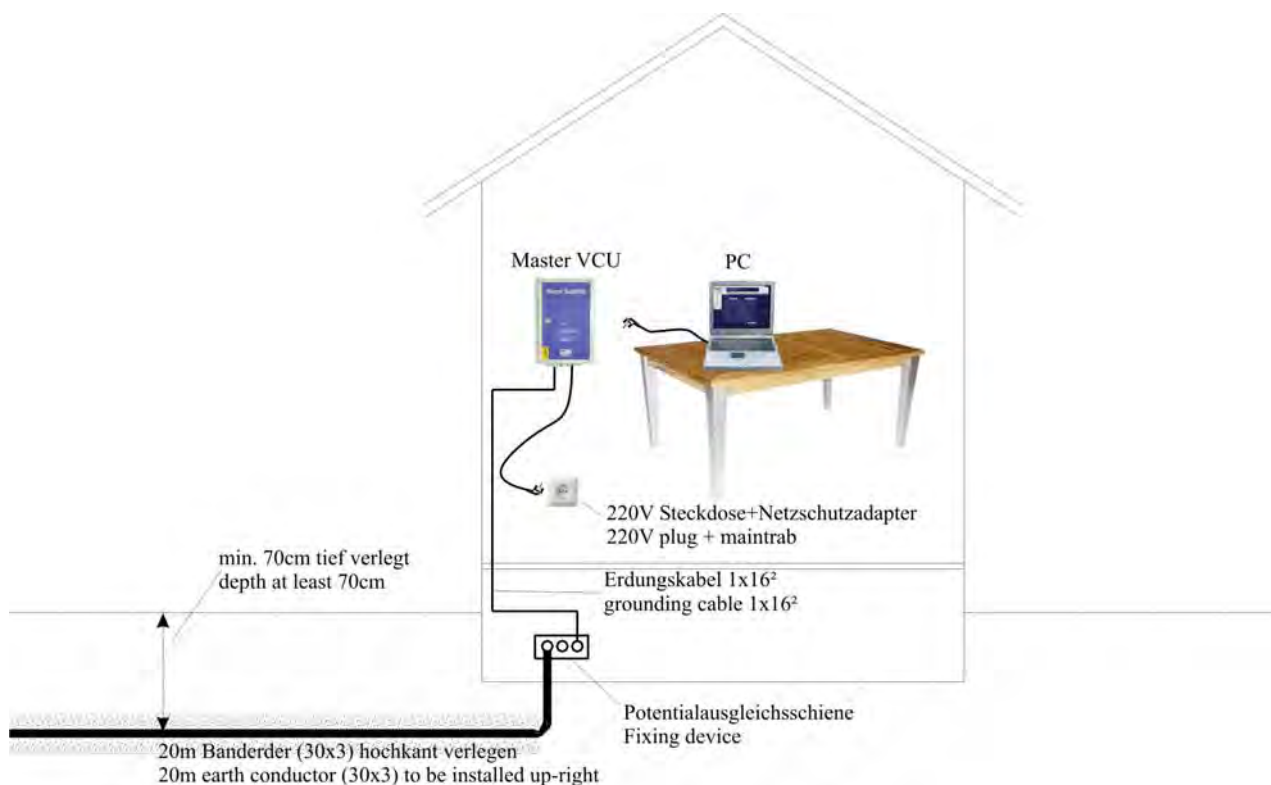

2.3 Networking of Satellites to Master VCU

Up to 250 stations can be controlled with the Master VCU. More stations (up to 2000) can be controlled through satellite VCUs connected to the Master VCU (up to 7 Satellites can be connected to the VCU).

The following must be observed in connecting:

a) Power supply and grounding

☆ Grounding

If the Master VCU is installed in the immediate vicinity of a Satellite VCU, grounding can be bridged from the Master to the Satellite.

If these units are far apart, each (Master and Satellite) must be grounded separately – see chapter 2.2.

☆ Connect the Satellite to its own power supply socket – in the same way as the Master VCU (see chapter 2.2).

b) Communication

The PC sends orders to the Master VCU, which forwards them to Satellite 1, from Satellite 1 to Satellite 2, etc.

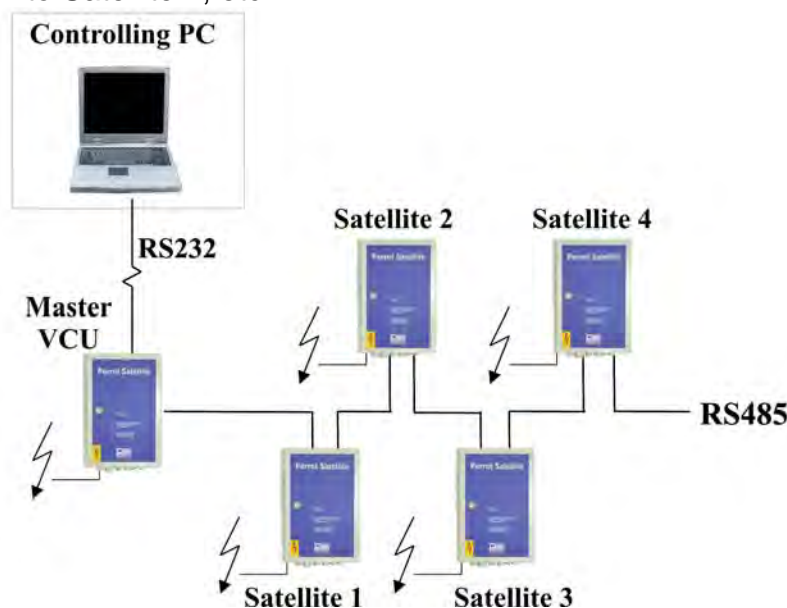

In order to communicate like this, the Master must be interconnected with the Satellites with one communication cable. Please respect the following points:

- ☆ Use a shielded twisted-pair cable (such as NYCY 2×1.5/1.5mm²)
- ☆ minimum cable gauge (cross section) for a distance of:
- ☆ 1000 m: 1.5 mm²
- ☆ 2500 m: 2.5 mm²

Setting up the DIP switches (only in Satellites)

- ☆ Satellite 1: DIP 2 is in position 1, all the others are in position 0
- ☆ Satellite 2: DIP 1 is in 1, DIP 2 is in 1, all the others are in 0
- ☆ Satellite 3:etc.

See the following drawing.

Wiring Diagram for RS 485 Communication

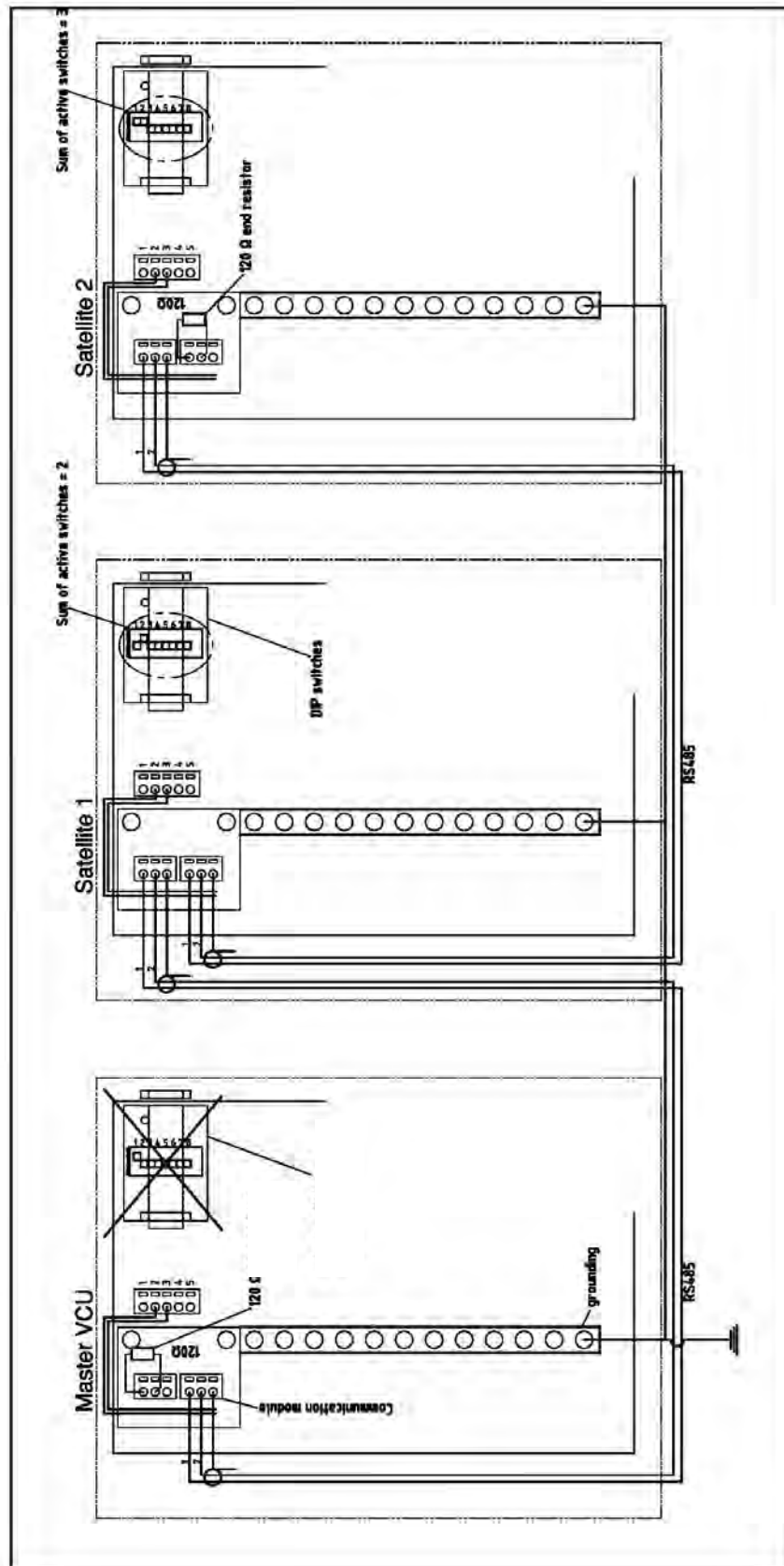

2.4 VCU Wiring Diagram

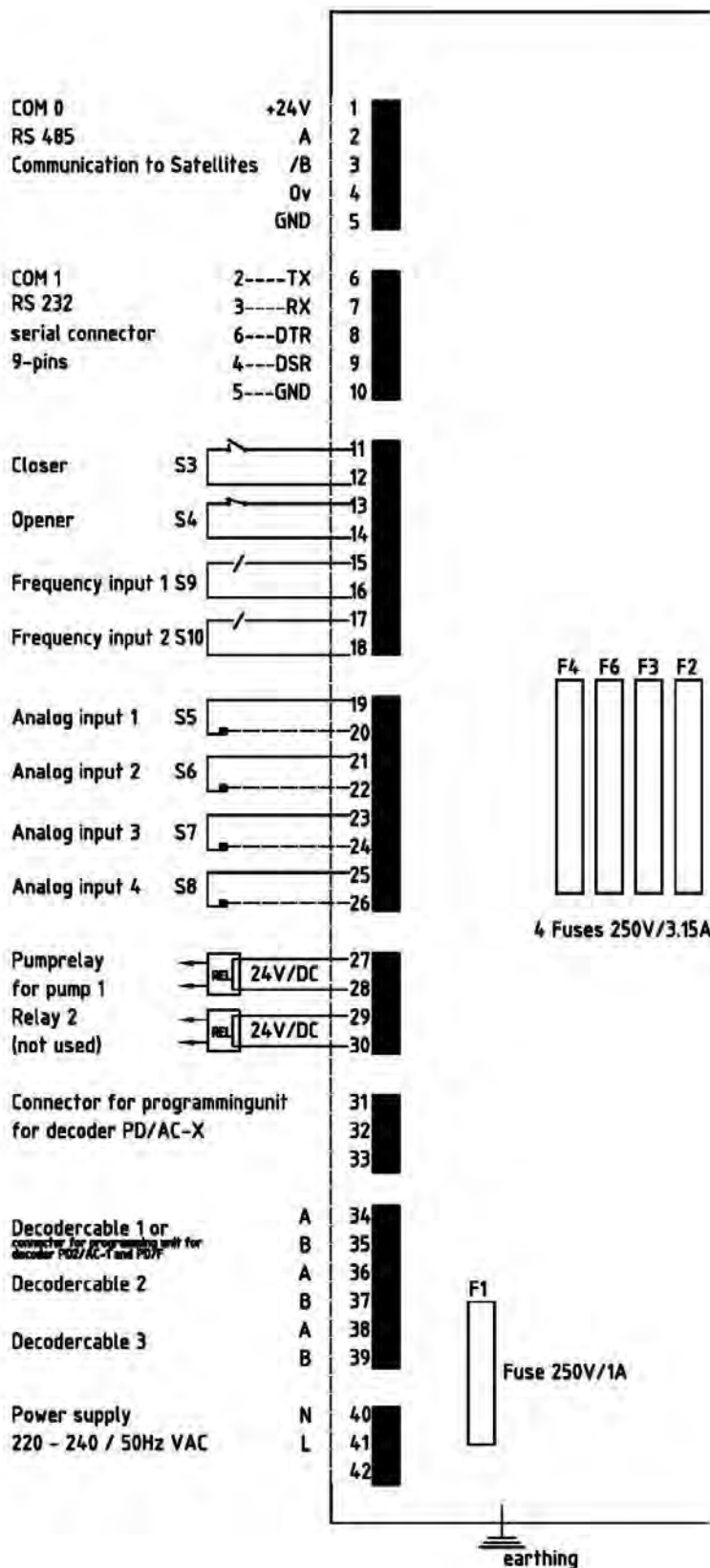

2.5 Decoder Wiring Diagram

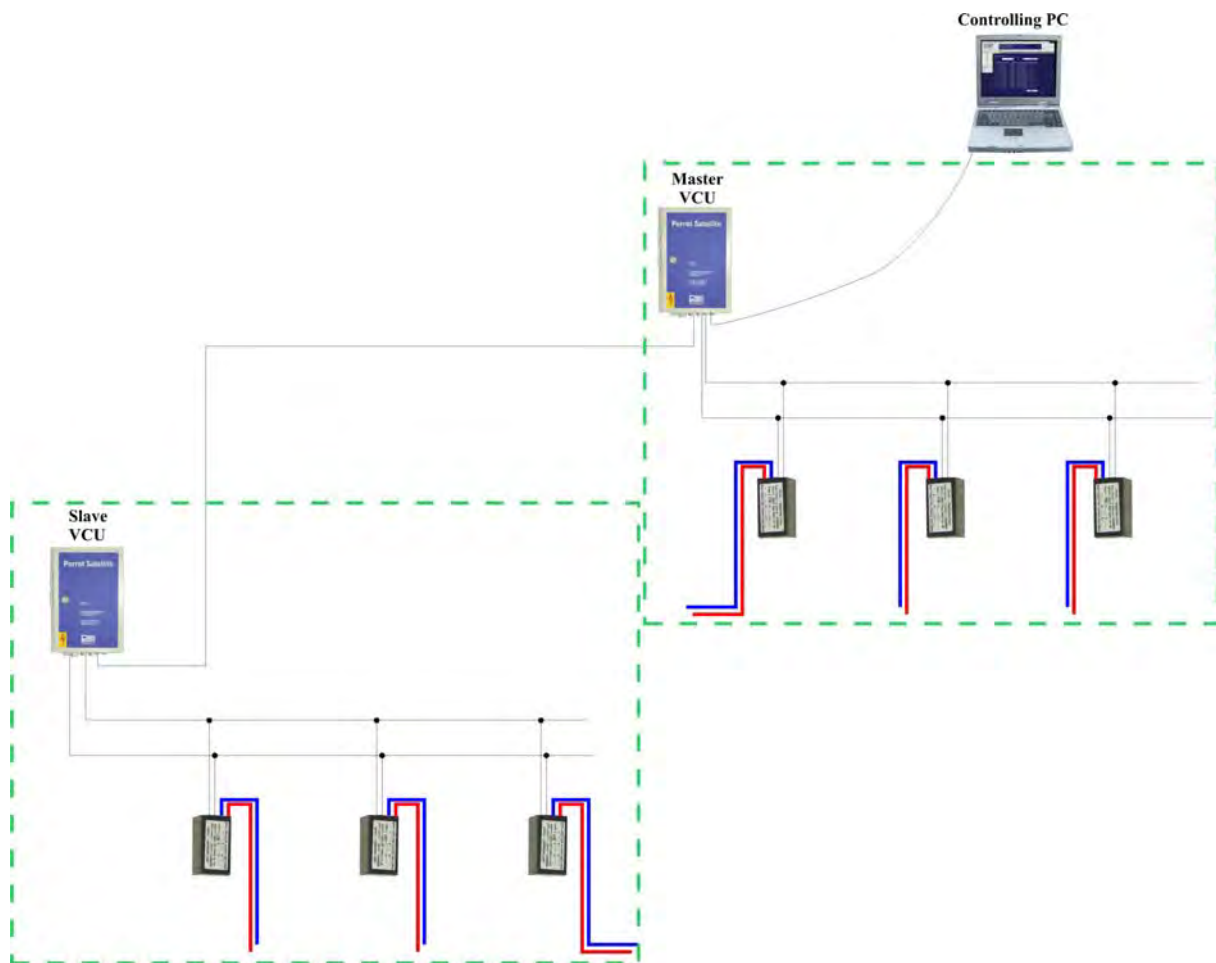

- ☆ Up to 250 decoders can be connected to each VCU.
- ☆ Each VCU has a separate cabling system and **MUST NOT** be interconnected with another VCU through a decoder cable.

A) Decoder Wiring for Controlling One Coil

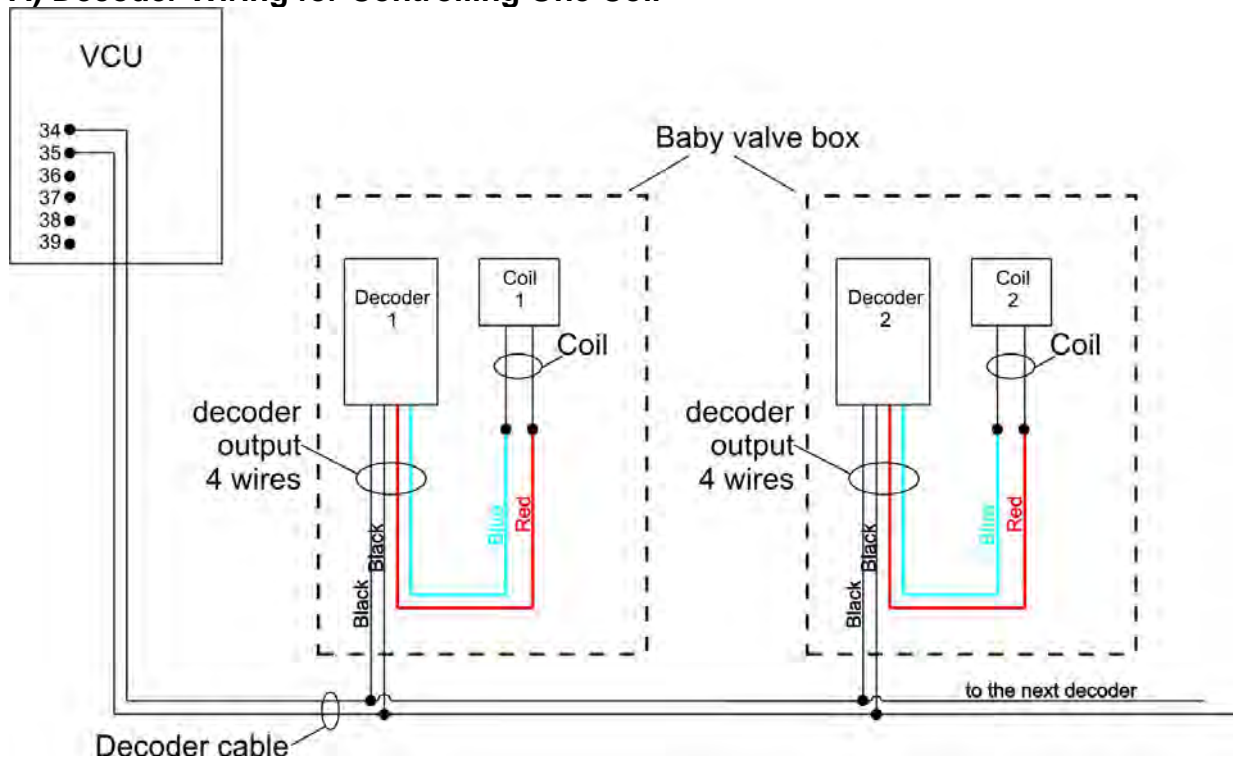

B) Decoder Wiring for Controlling 2 Coils

Cable installation to pop-up sprinklers connected in series

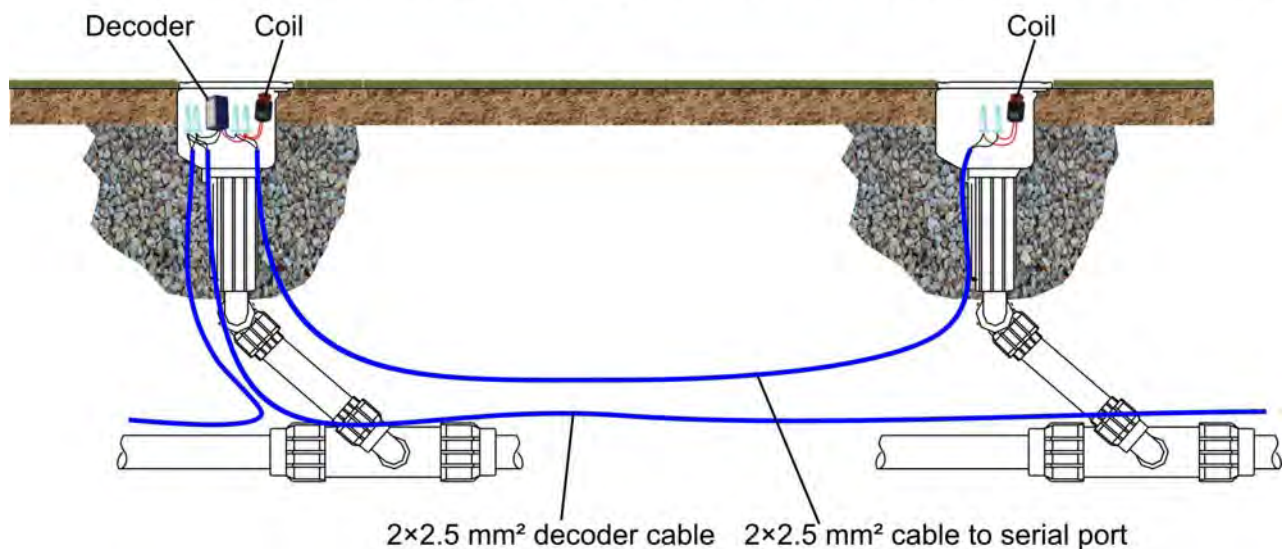

Decoder Wiring for Controlling 2 Coils (serial connection)

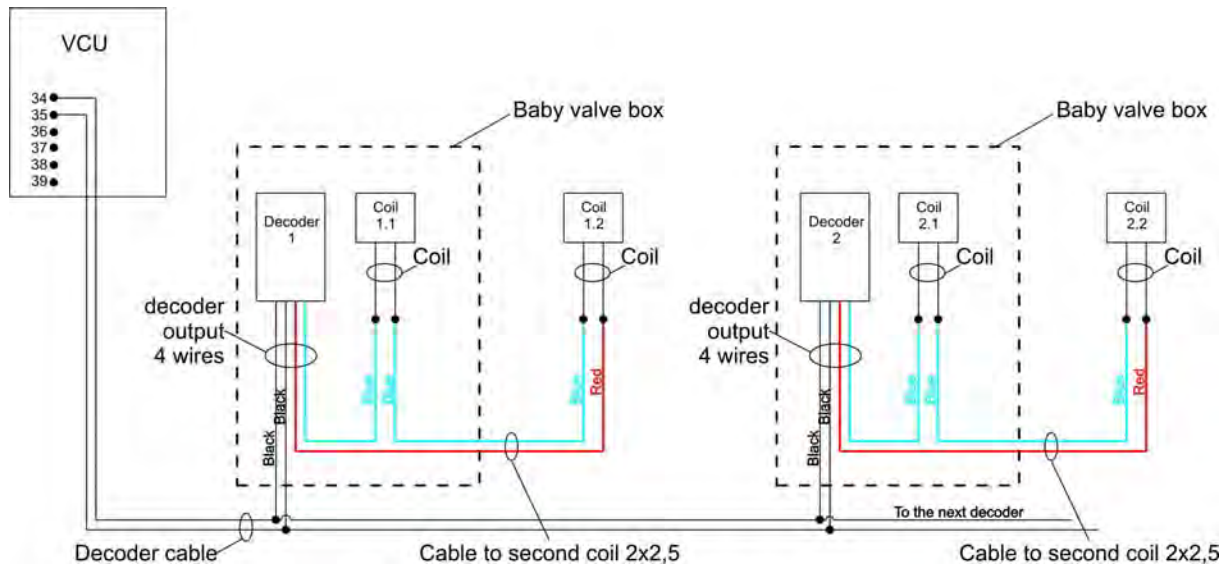

Coils are to be serial-connected to the decoder. This will achieve the best coil operation.

3 Software Installation

3.1 Preparation of PC for installation of Perrot Satellite

Check which operating system of Win7 is installed on your PC:

- ✓ Under “Start / Control Panel / System” you can look up whether your operating system works with 32 or 64 bit. This information will be required later for the installation of the SQL server.

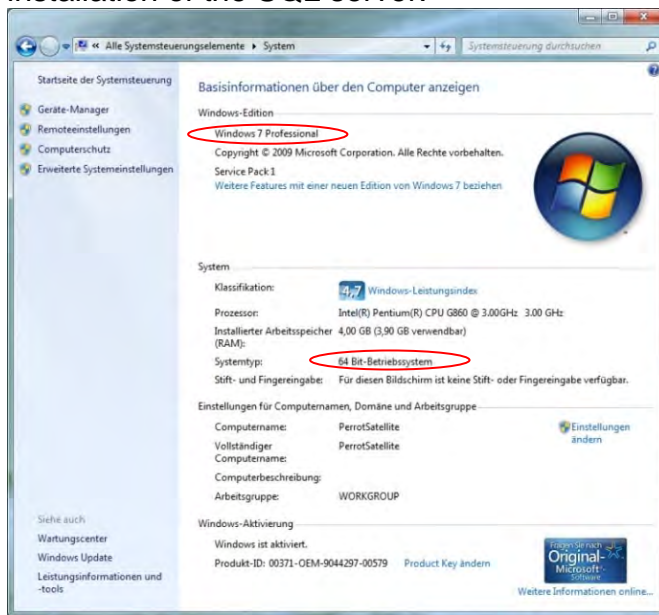

3.2 Requirements on PC and operating system

Following minimum requirements are needed for the installation of Perrot Satellite:

- ✓ AMD Athlon 64 or Pentium 4, min. 1 GHz
- ✓ Min. 1,024 GB RAM, approx. 40 GB memory on hard drive
- ✓ Operating system Windows 7 Professional SP1
- ✓ Microsoft Internet Explorer until version 11
- ✓ Serial interface RS 232 (COM1) for the connection with the valve control unit
- ✓ Network interface card: Ethernet 100 Mbit
- ✓ VGA colour screen, resolution 1024 x 768 (resolution when using laptop 1280 x 800)
- ✓ Optional: remote control via smartphone is only possible with DSL connection using a fixed IP address

3.3 Order of installation

Please keep the following order of installation!

3.3.1 SQL-Server

- ✓ Please place the Perrot Satellite CD into the drive for the installation of the SQL server. Open the CD via the Windows Explorer and proceed opening the “SQL Setup” folder.

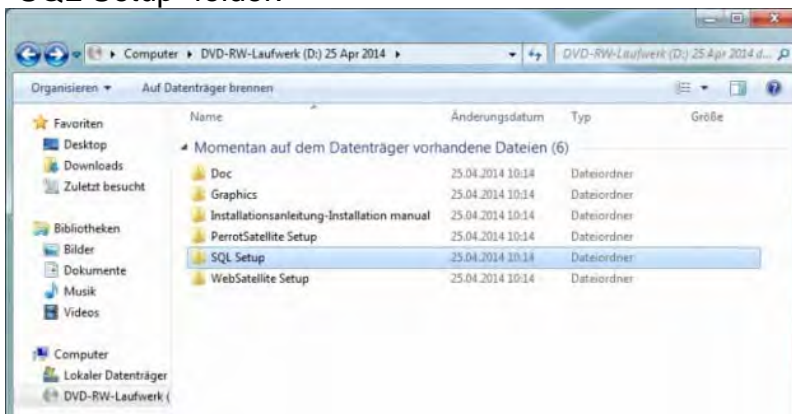

- ✓ Please make sure to choose the right file for your operating system. Open the corresponding file with a double click and follow the instructions on the screen.
32 bit system, file: **„en_sql-server_2008_r2_express_x86“**
64 bit system, file: **„SQLEXPRESS_x64_ENU“**

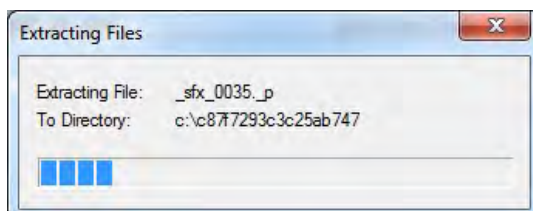

- ✓ Select **„New Installation or Add Features to an Existing Installation”** in the SQL server installation center.

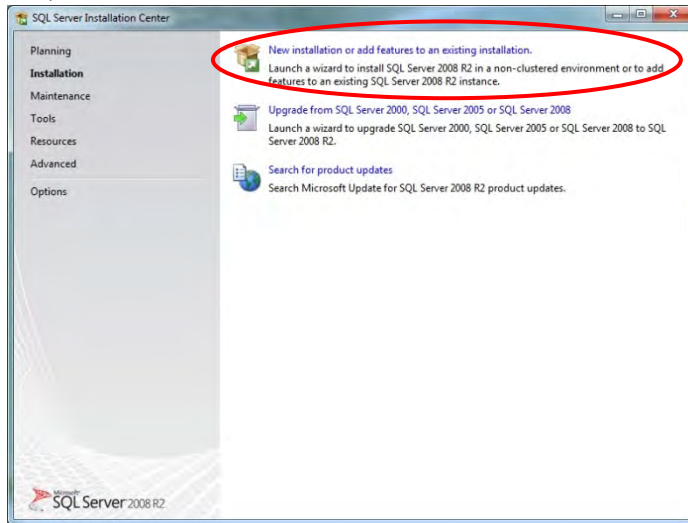

- ✓ Accept the license conditions by putting a check at the field **„I accept the license terms”** and click on the button **“Next”**.

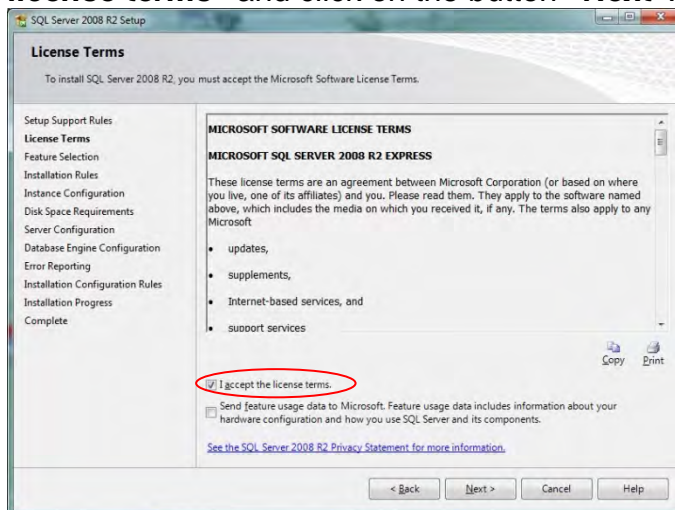

- ✓ Proceed with **“Next”**.

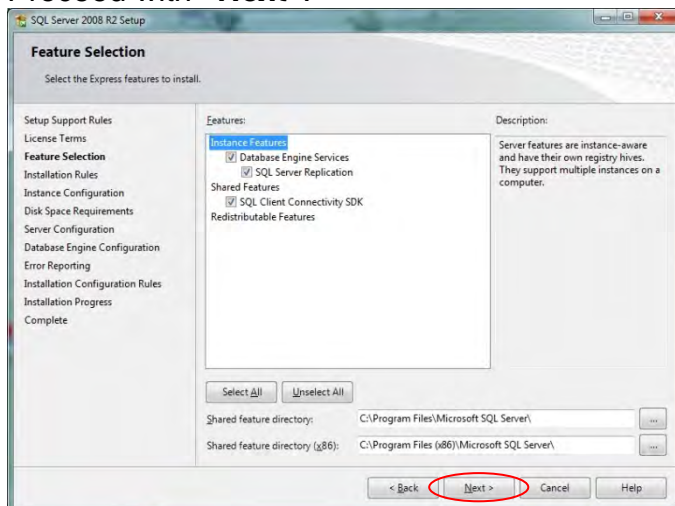

- ✓ Proceed with **“Next”**.

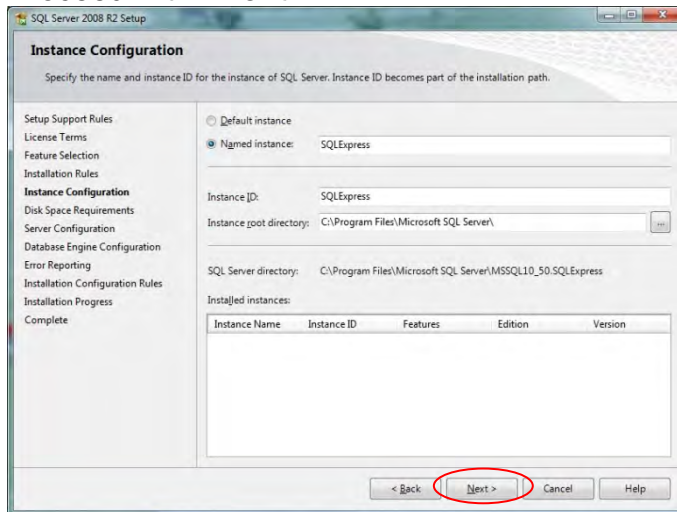

- ✓ Proceed with **“Next”**.

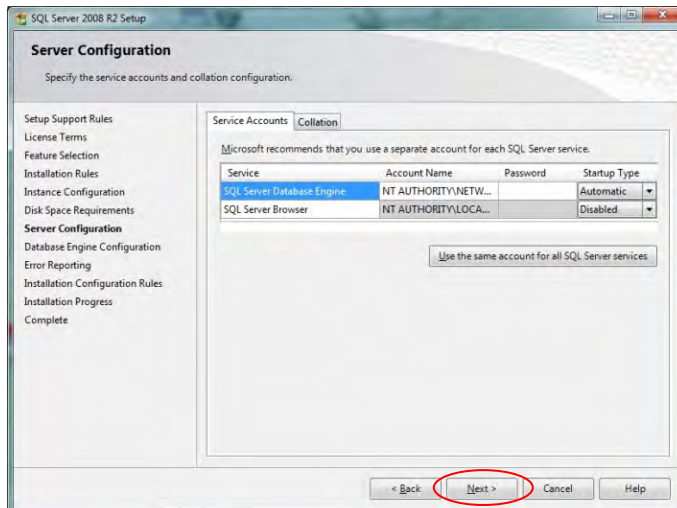

- ✓ Once you reach the **„Database Engine Configuration“** change the **“Authentication Mode”** to the setting **“Mixed Mode”** and insert the following passwords:
Enter password: **satellite**
Confirm password: **satellite**

- ✓ Proceed with a click on „Next“.

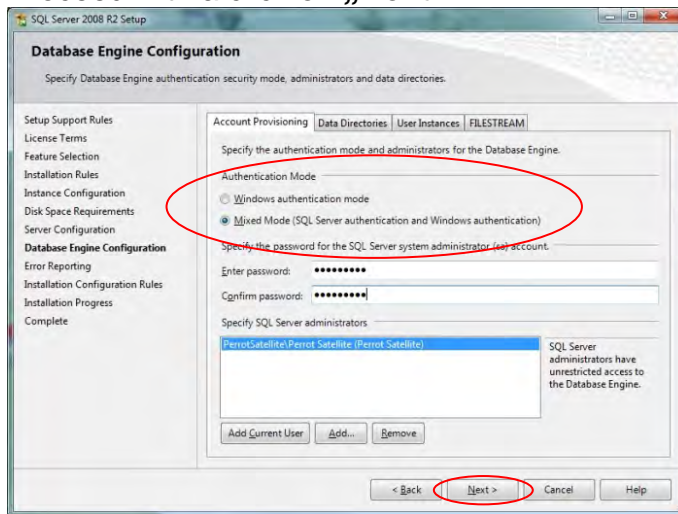

- ✓ Proceed with „Next“.

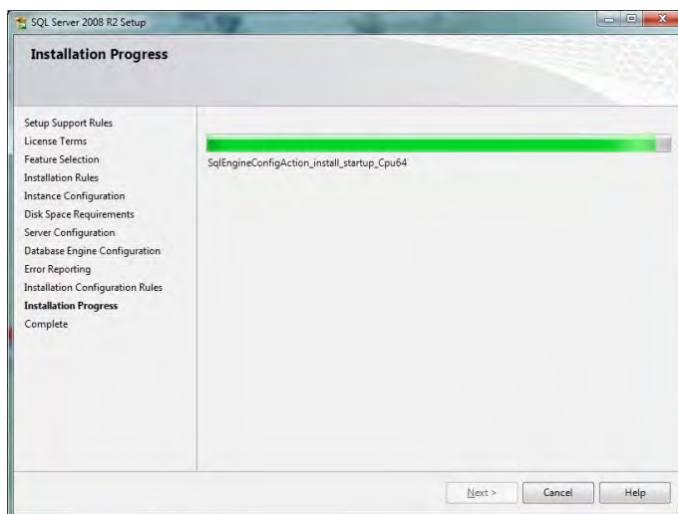

- ✓ Complete the installation with „Close“.
- ✓ All other open windows need to be closed manually.

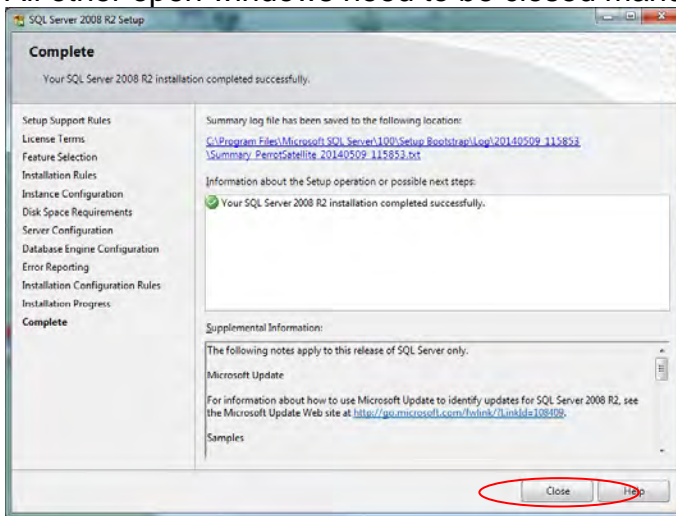

3.3.2 IIS (Internet Information Service)

- ✓ Follow the menu point „**Start / Control Panel**“ and open “**Programs and Functions**” with a double click.

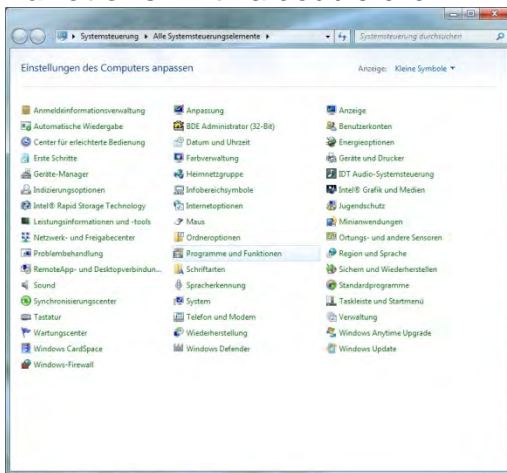

Select „**Activate and Deactivate Functions of Windows**“.

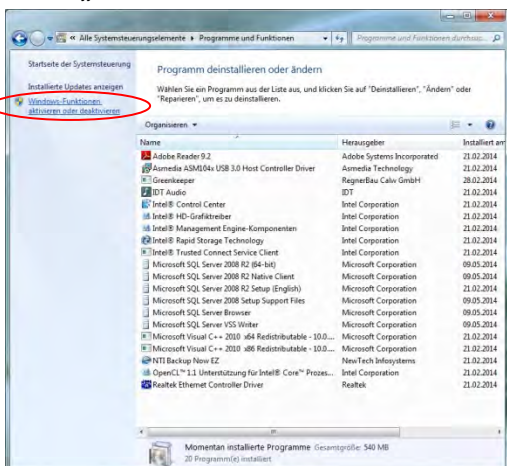

- ✓ Open the sub-point at „**Internet Information Service / WWW Services / Application Development for Features**” by clicking on the plus-sign. Tick the box at „**ASP.NET**“. The two settings „ISAPI” and „NET” will get ticked automatically. Confirm with “OK”.
Close all open windows and **restart the PC**.

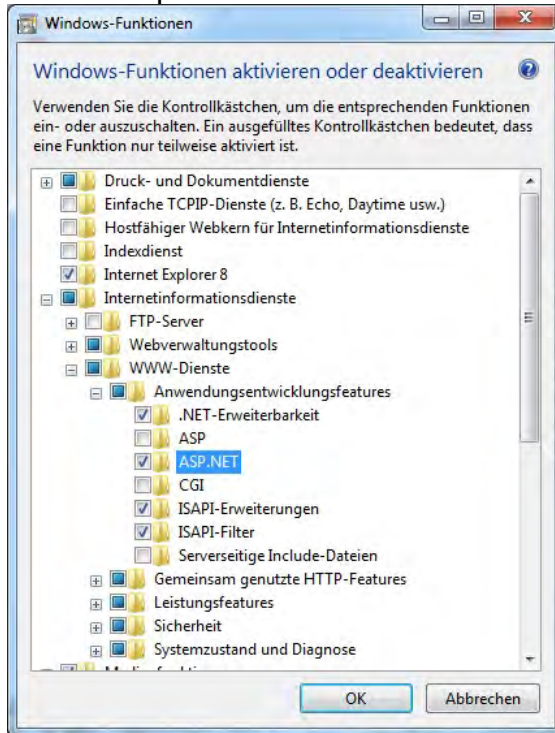

3.3.3 Perrot Satellite

- ✓ Re-open the Perrot Satellite CD in the Windows Explorer and open the folder named „**Perrot Satellite Setup**“.

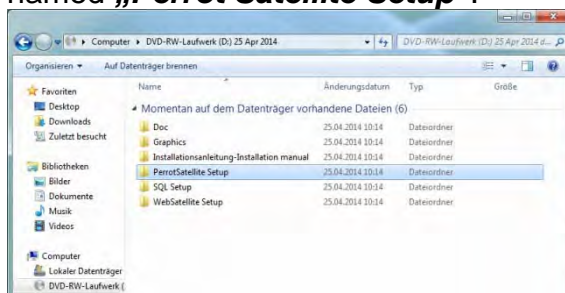

- ✓ Open the file **„CreateSatelliteDb“** with a double click.

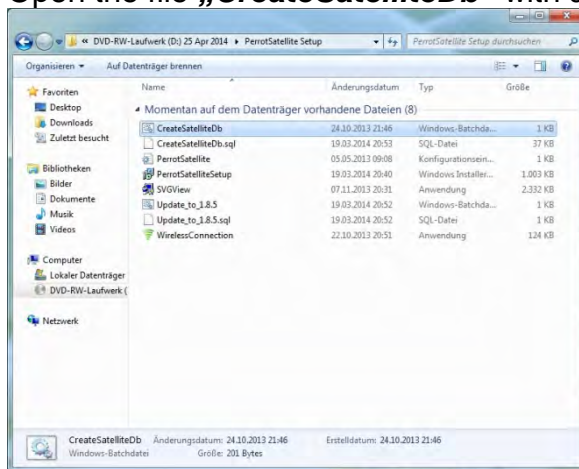

- ✓ Press any button on your keyboard to close the following window automatically.

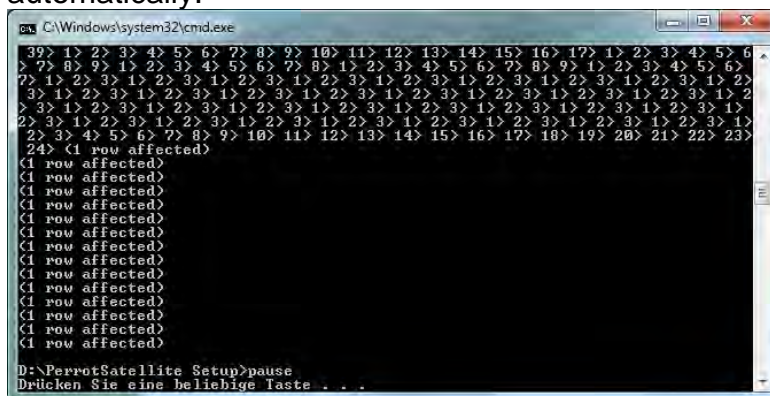

- ✓ Open the next file **“PerrotSatelliteSetup“** with a double click.

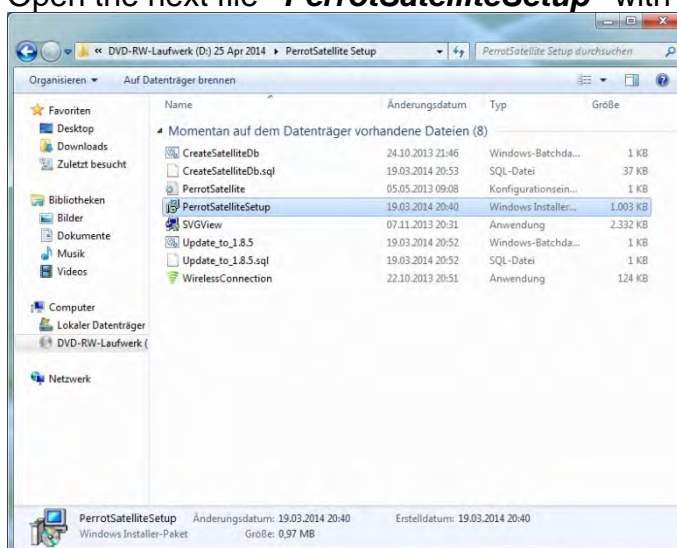

- ✓ Proceed with **“Next”**.

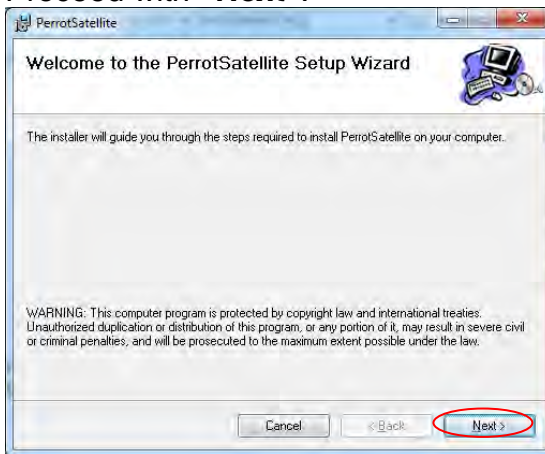

- ✓ Change the settings from **„Everyone“** to **“Just me”** and then click **“Next”**.

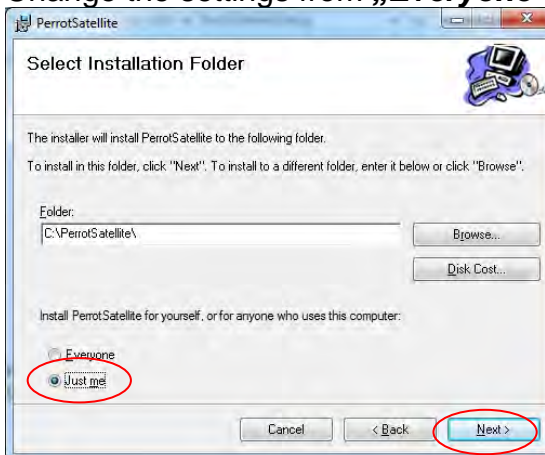

- ✓ Proceed with **“Next”**.

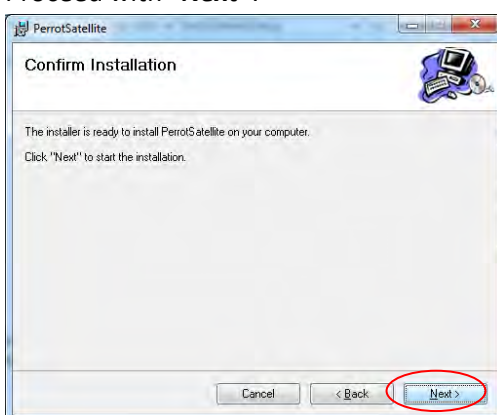

- ✓ To complete the installation select **„Close“**.

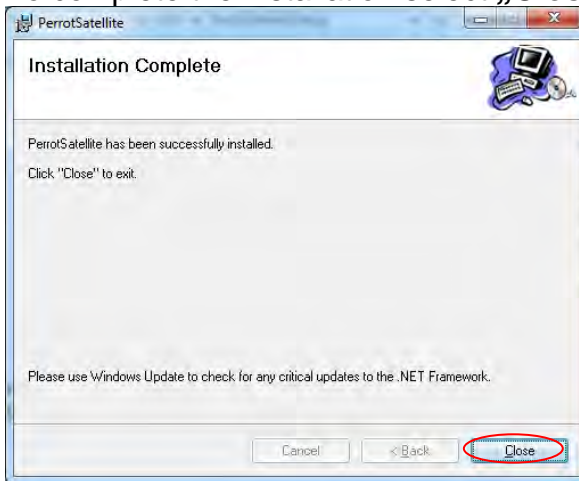

- ✓ In the next step the SVG server will be installed. Open the file **„SVG View“** with a double click.

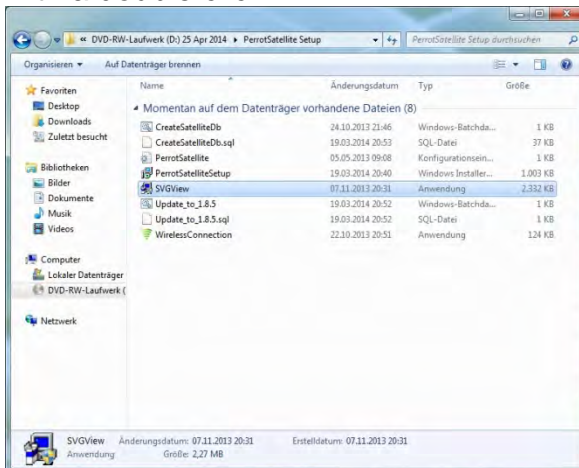

- ✓ Complete the installation with **„Close“** and close all open windows.

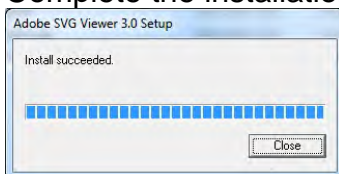

3.3.4 WebSatellite

- ✓ Re-open the Perrot Satellite CD in the Windows Explorer and open the folder „WebSatelliteSetup“.

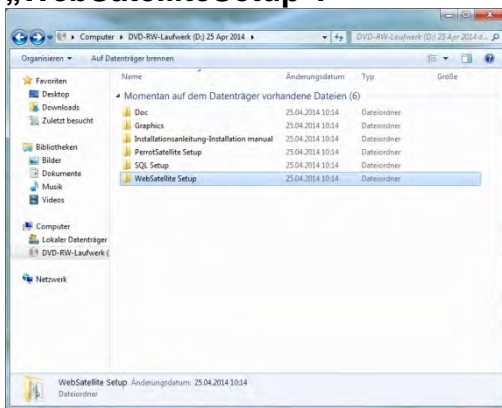

- ✓ Open the file „WebSatelliteSetup“ with a double click to start the installation.

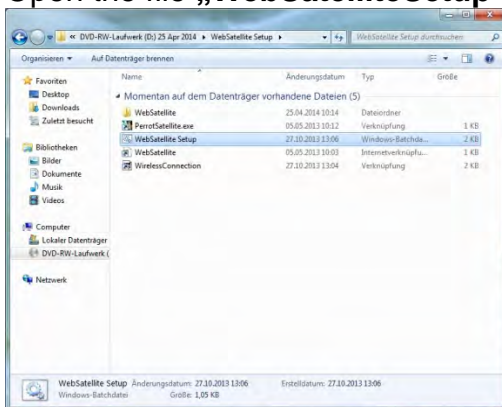

- ✓ Once the installation has been completed, the window will close automatically.



- ✓ Open the Windows Start Button, insert “IIS” in the search bar and press enter. Select the **“Internet Information Services (IIS) Manager”** which appears under **“Programs”**.

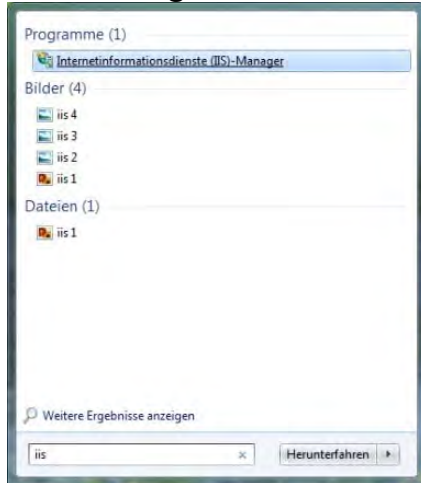

- ✓ Alternatively the file can also be opened by following the menu points **“Start / Control Panel / Administration / IIS Manager”**.

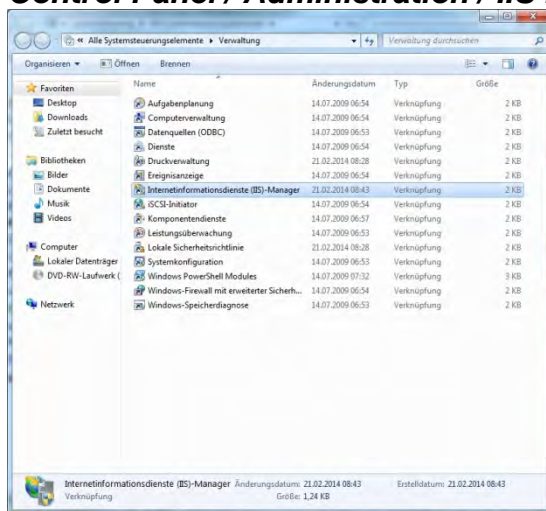

- ✓ Click on the plus-sign to open the sub-menus on the left side and select „**Default Web Site**“.

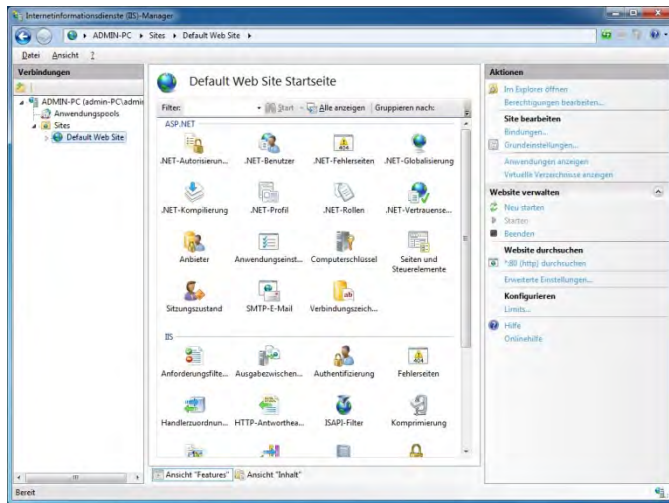

- ✓ With the right mouse button click on „**Default Web Site**“ and select „**Remove**“.
Confirm with „**Yes**“.

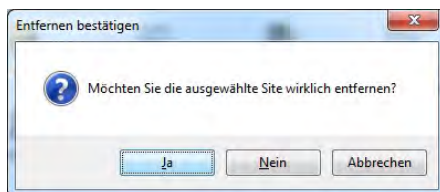
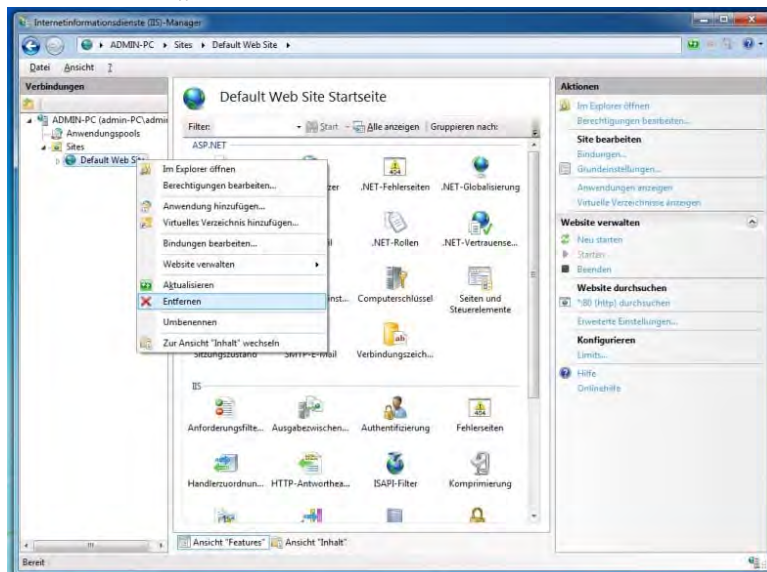

- ✓ Select **„Sites“** with the right mouse button and choose the menu point **„Add Website“**.

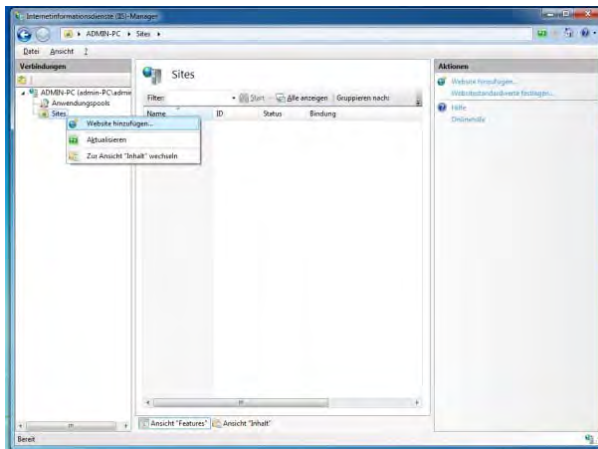

- ✓ As **„Sitename“** insert **„WebSatellite“** and proceed with a click on the button **„...“** besides the field **„Physical Path“**.

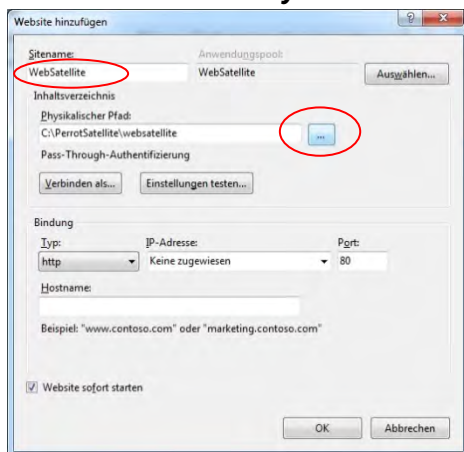

- ✓ At **„Computer / Local Data Storage (C:) / Perrot Satellite“** select the folder **„websatellite“** and confirm with **„OK“**.

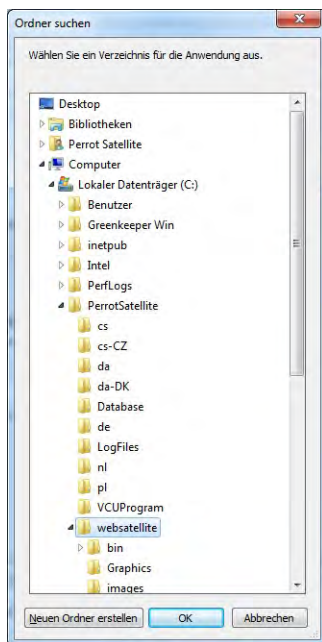

- ✓ The newly generated folder now shows up under the point „**Sites**“. Close all windows.

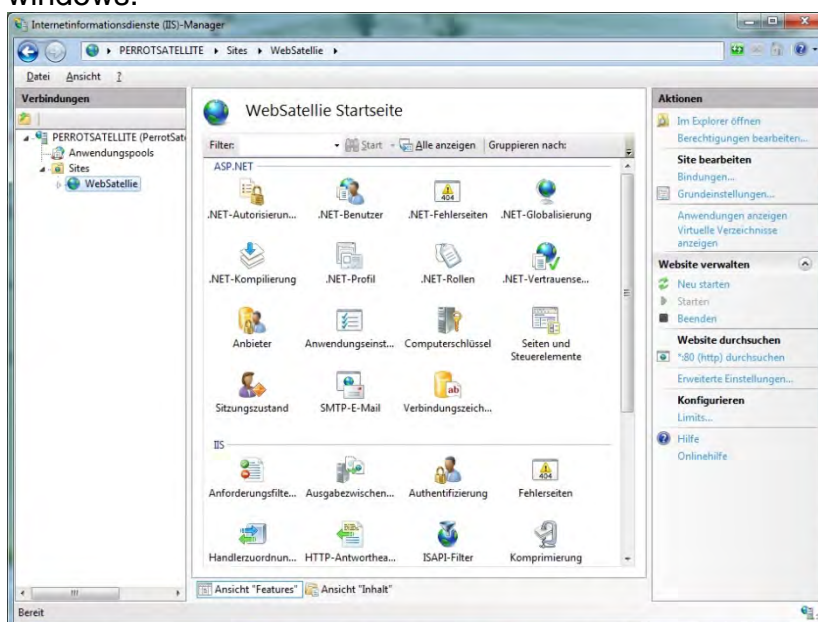

3.3.5 Setting up Internet Explorer

- ✓ Start Internet Explorer.
- ✓ Go to the following menu path: **Tools > Internet Options > General > Settings > Check for newer versions of stored pages** and choose the **"Every time I visit the webpage"** option.

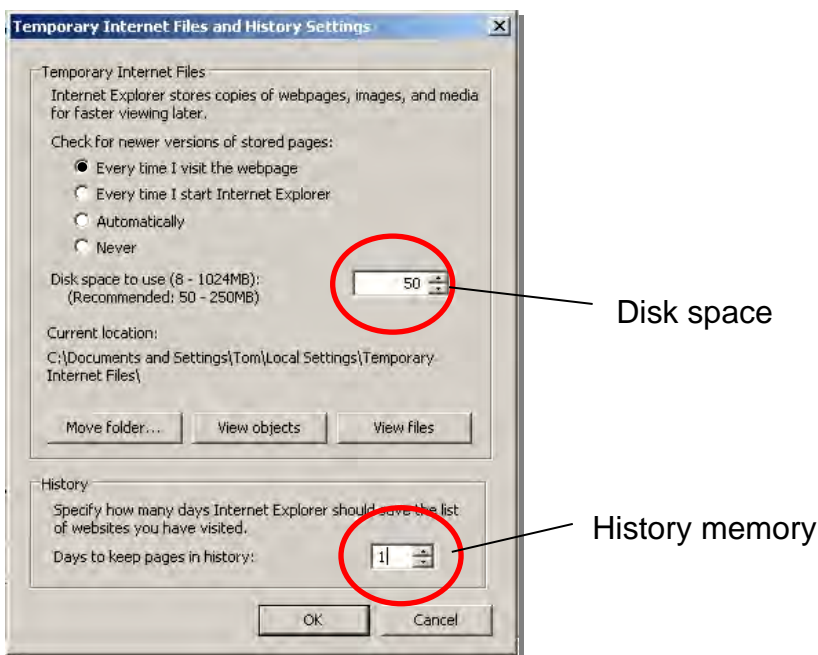
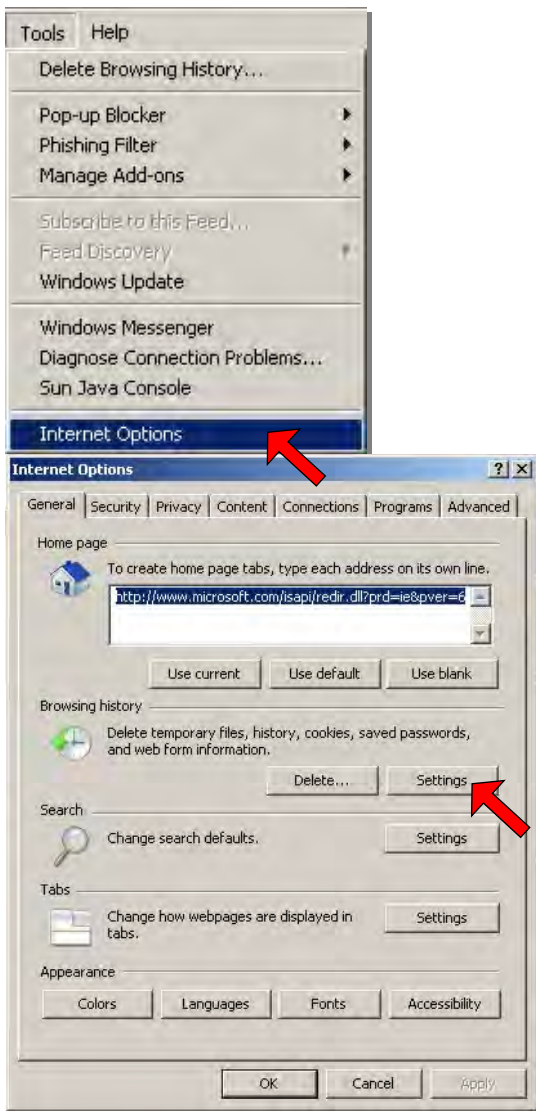



To provide enough hard-disc space for working, it is recommended to use the values of the **Disk space** and the **Days to keep pages in history** as indicated in the previous screenshot. Then confirm your selection by clicking the  button.



3.3.6 Troubleshooting

If the creation of the *Perrot Satellite* database fails, then restart the computer. After the restart, check the right corner of the Windows status bar and make sure you can see this SQL server icon:  Run the "**CreateSatelliteDB.bat**" program again.

3.3.7 Language Setup

1. *Perrot Satellite* is a web-based program, which can be used for remotely controlled applications. For this reason it consists of two main parts:
 - ✓ The first part is *Satellite Browser*, which provides the user interface.
 - ✓ The second part is *Perrot Satellite*, which provides communication with the VCU.

2. Language Selection

2.1. Language Selection for *Satellite Browser*

- ✓ *Satellite Browser* runs and is controlled under Internet Explorer. Therefore the language selection also must be made in Internet Explorer.
- ✓ To select your required language, open Internet Explorer, go to the menu and choose: **Tools > Internet Options**.

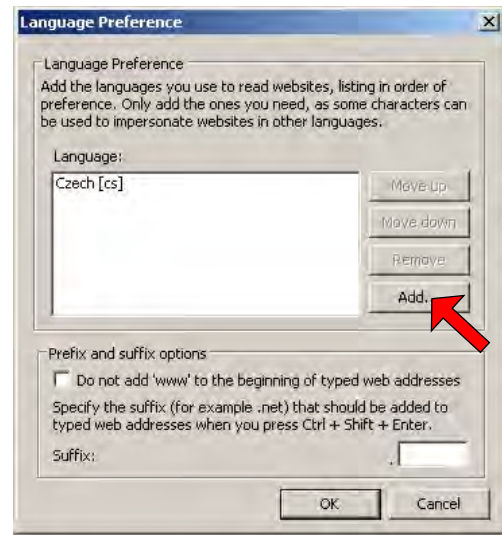

- ✓ Click the **Languages** button and choose the required language from the list or use the **Add...** button to add it to the list. Before that make sure that *Perrot Satellite* supports your language.

2.2 Language Selection for the *Perrot Satellite*

- ✓ *Perrot Satellite* is controlled from Windows, therefore the language selection must be done in Windows settings. Click **Start > Settings > Control Panel > Regional and Language Options**.

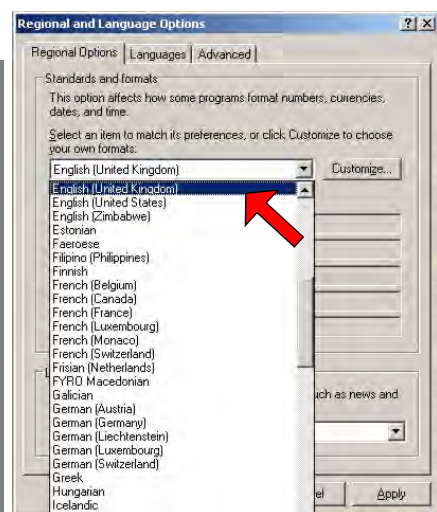
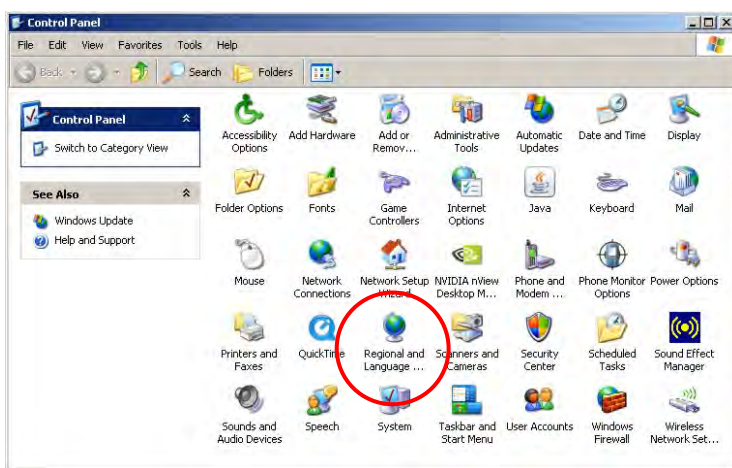

- ✓ Go the **Regional Options** tab and choose the required language from the combo-box. Before that, make sure that *Perrot Satellite* supports the language required by you.

3. Recommendations for the language settings:

3.1 Language settings at a local (client) PC, i.e. the PC is directly connected to the VCU:

- ✓ In this case, Satellite Browser and *Perrot Satellite* **must** have the same language selected.

3.2 Language settings at a remote PC:

In this case, you must select the same language for Satellite Browser as already selected in *Perrot Satellite*.

Other settings might cause communication problems.

3.4 Checking the Communication between PC, Master VCU & Satellites

To check the correct connections of all interfaces, run the *Perrot Satellite* program (see chapter 4) and go to the following menu path: **Setup > Satellites > Satellite**.

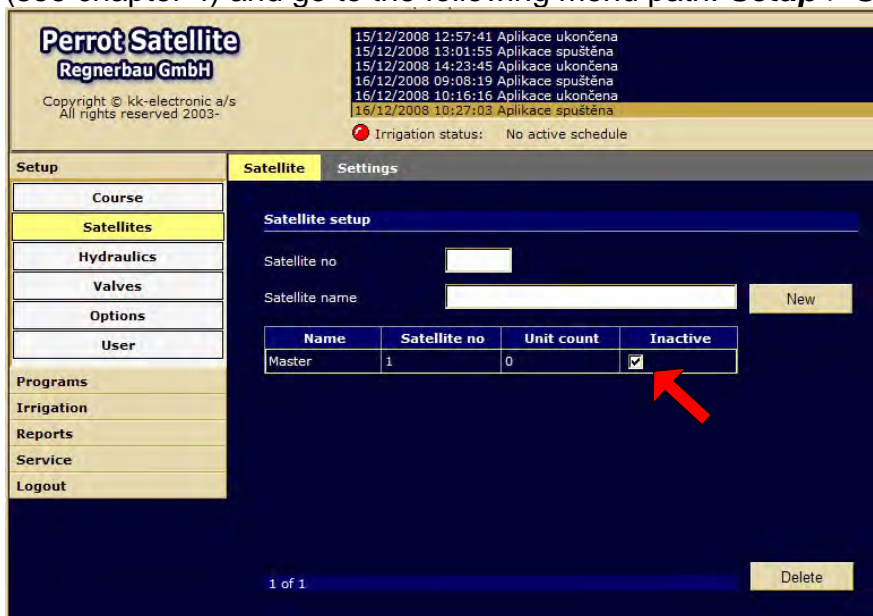

After you have keyed in all necessary Master VCU data and possible satellite data (see chapter 5), activate the Master VCU by removing the tick from the "**Inactive**" box.

The go to the **Service > Satellite > General** menu:

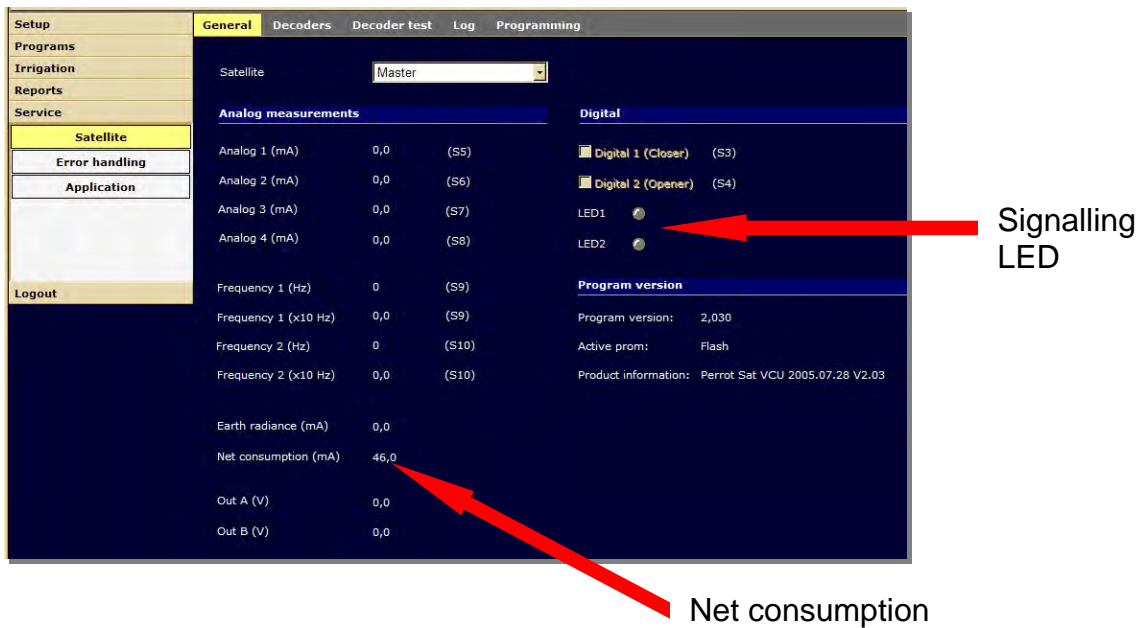

The screenshot shows the 'General' tab of the software interface. It features a sidebar on the left with menu items like 'Setup', 'Programs', 'Irrigation', 'Reports', 'Service', 'Satellite', 'Error handling', 'Application', and 'Logout'. The main area is divided into 'Analog measurements' and 'Digital' sections. The 'Analog measurements' section includes a table with columns for measurement type, value, and status. The 'Digital' section includes controls for 'Digital 1 (Closer)', 'Digital 2 (Opener)', and two LEDs (LED1 and LED2). A 'Program version' section at the bottom right displays version and product information. Two red arrows are overlaid on the image: one points to the 'Net consumption (mA)' value of 46,0 in the 'Analog measurements' table, and the other points to the 'LED1' status indicator in the 'Digital' section.

Analog measurements			Digital	
Satellite	Master			
Analog 1 (mA)	0,0	(S5)	Digital 1 (Closer)	(S3)
Analog 2 (mA)	0,0	(S6)	Digital 2 (Opener)	(S4)
Analog 3 (mA)	0,0	(S7)	LED1	<input checked="" type="checkbox"/>
Analog 4 (mA)	0,0	(S8)	LED2	<input checked="" type="checkbox"/>
Frequency 1 (Hz)	0	(S9)	Program version	
Frequency 1 (x10 Hz)	0,0	(S9)	Program version:	2,030
Frequency 2 (Hz)	0	(S10)	Active prom:	Flash
Frequency 2 (x10 Hz)	0,0	(S10)	Product information:	Perrot Sat VCU 2005.07.28 V2.03
Earth radiance (mA)	0,0		Net consumption	
Net consumption (mA)	46,0			
Out A (V)	0,0			
Out B (V)	0,0			

If the **Net consumption** value is higher than 0, connection to the PC has been established.

You can also check that the connection has been established by means of the yellow LED on the Master VCU which must be blinking; and/or on the same screen in the **Digital** section where this function is signalled.

3.5 Uploading the VCU Software

You need to have the "**technician**" user rights to upload or update the VCU software. Perform the software upload only if:

- a) you need to update the system from Greenkeeper to *Perrot Satellite*,
- b) VCU software has "frozen" (this happens very rarely),
- c) the manufacturer supplies a new software version.
 - ✓ The current *Perrot Satellite* software version (1.016) can be displayed under **Service > Satellite > General > Program version**:
 - ✓ Program version: 2.030
 - ✓ Active Prom: Flash
 - ✓ Product information: Perrot Sat VCU2005.07.28 V.2.03



Before uploading software to the VCU, the VCU must be switched to the "**Inactive**" mode.

You can do so in the **Setup > Satellites > Satellite** menu by ticking the "**Inactive**" box.

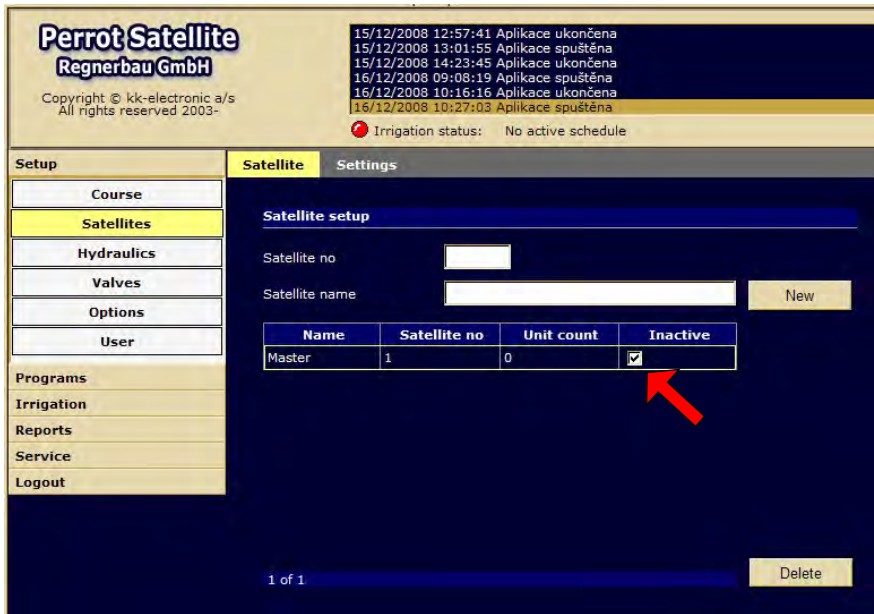

Perrot Satellite
Regnerbau GmbH
Copyright © kk-electronic a/s
All rights reserved 2003-

15/12/2008 12:57:41 Aplikace ukončena
15/12/2008 13:01:55 Aplikace spuštěna
15/12/2008 14:23:45 Aplikace ukončena
16/12/2008 09:08:19 Aplikace spuštěna
16/12/2008 10:16:16 Aplikace ukončena
16/12/2008 10:27:03 Aplikace spuštěna

Irrigation status: No active schedule

Setup | **Satellite** | **Settings**

Course
Satellites
Hydraulics
Valves
Options
User

Programs
Irrigation
Reports
Service
Logout

Satellite setup

Satellite no:
Satellite name:

Name	Satellite no	Unit count	Inactive
Master	1	0	<input checked="" type="checkbox"/>

1 of 1

Proceed as follows in the **Service > Satellite > Programming** menu:

1. Select the satellite to program.
2. Click the **File** combo box and choose **PE_Main.HEX**.
3. Start the software upload by clicking the **Program** button.
4. The **Programming status** will change from "Passiv" to "Deleting" and then to "Programming".
5. The blue strip shows the uploading progress.

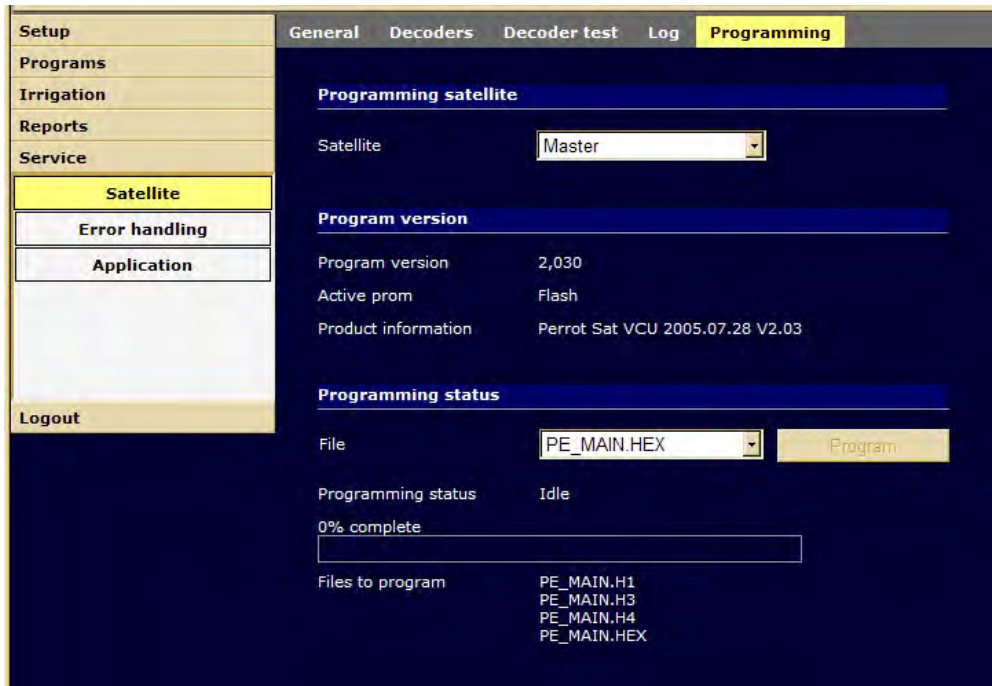

Setup | **Programs** | **Irrigation** | **Reports** | **Service**

Satellite | **Error handling** | **Application**

Logout

General | Decoders | Decoder test | Log | **Programming**

Programming satellite

Satellite:

Program version

Program version: 2,030
Active prom: Flash
Product information: Perrot Sat VCU 2005.07.28 V2.03

Programming status

File:

Programming status: Idle
0% complete

Files to program: PE_MAIN.H1
PE_MAIN.H3
PE_MAIN.H4
PE_MAIN.HEX

Once the uploading procedure is complete, you can remove the tick from the **Inactive** box of the corresponding VCU under the **Setup > Satellites > Satellite** menu.

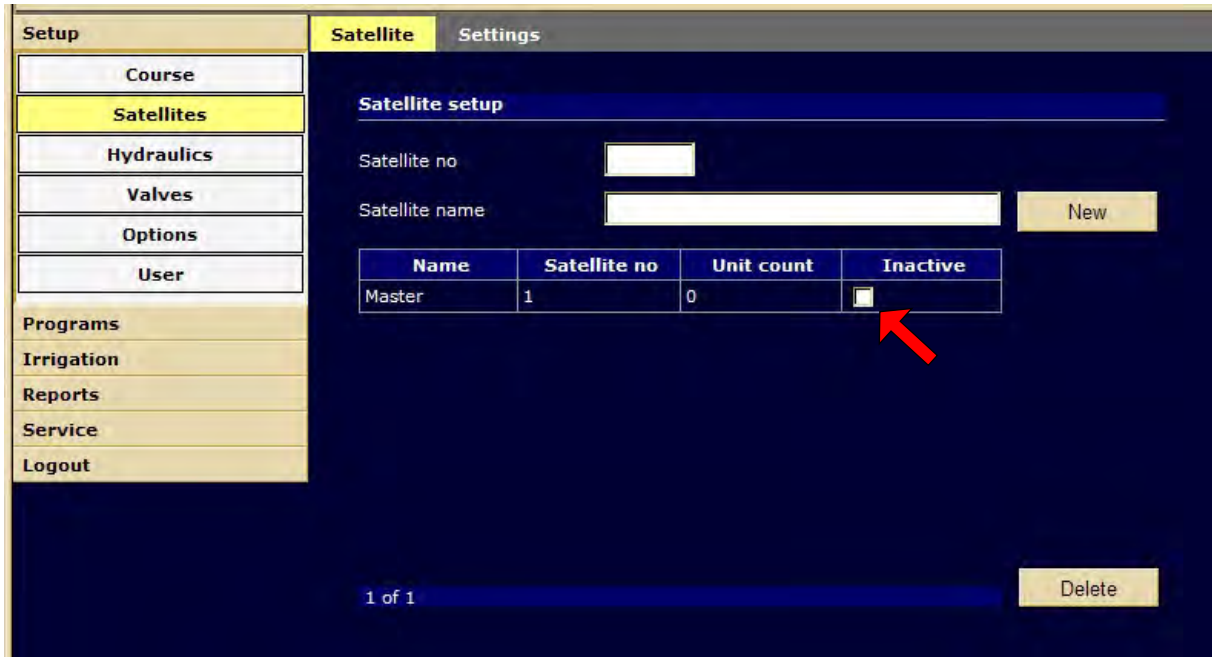

Now your PC should communicate with the VCU. You can check it the following ways:

- ✓ The yellow LED on the VCU is blinking.
- ✓ The voltage and current values (Net consumption) of the VCU under the **Service > Satellite > General** menu are displayed. If no connection has been established, both these values will be 0 (zero).
- ✓ No communication error is displayed in the *Perrot Satellite* status line.

4 Working with *Perrot Satellite*

Perrot Satellite is a WEB-based irrigation program. For this reason it consists of two parts:

1. *Perrot Satellite*
2. Satellite Browser

Perrot Satellite is the irrigation software itself, in which:

- ✓ all data is documented
- ✓ irrigation programs are created
- ✓ calculations are performed and applied.

This program part must always be active during irrigation.



We recommend:

To have *Perrot Satellite* running continuously throughout the irrigation season.

Satellite Browser is needed to open menus and corresponding screens in which data is displayed or entered. This is done by means of Internet Explorer as a user interface. *Perrot Satellite* can be controlled locally or remotely by any PC connected to the Internet. In order to control the software remotely, you need to create access rights (see chapter 9).

4.1 Starting *Perrot Satellite*

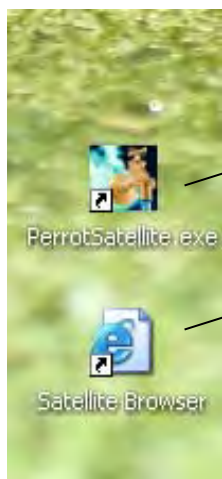

Program icons:

Perrot Satellite

Satellite Browser

To start the *Perrot Satellite* application, double click the "**Perrot Satellite**" icon.

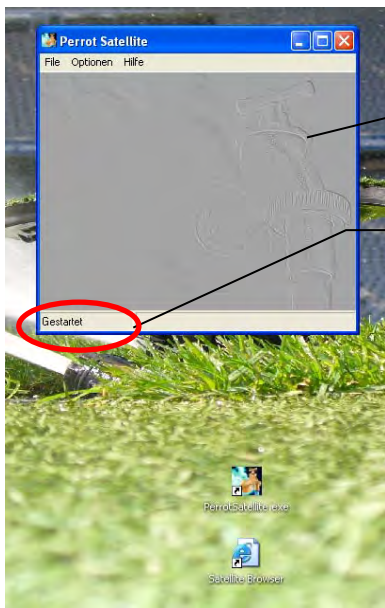

Perrot Satellite window

Status bar

A small window will open.

The left part of the status bar gives information on *Perrot Satellite* current status:

- ✓ Starting... after starting the application
- ✓ Started when the application is active
- ✓ Stopped when the application is stopped/interrupted.

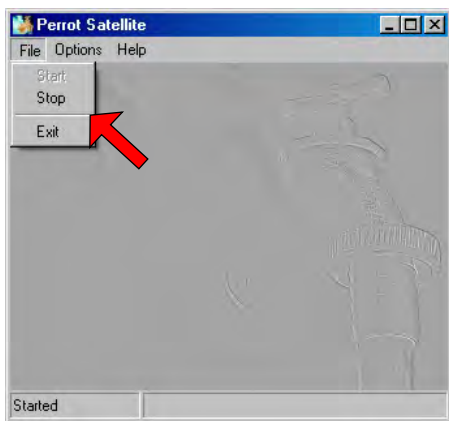

You can stop and exit the program by means of the corresponding items under the **File** menu.



The "**Satellite Browser**" user interface program must be closed before exiting the *Perrot Satellite* program. *Perrot Satellite* must always indicate "**started**" before you open Satellite Browser.

4.2 Starting Satellite Browser (user interface program)

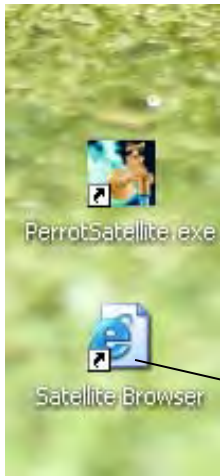

Satellite Browser

In order to work with *Perrot Satellite*, you must start Satellite Browser, which works as a user interface. You do so by double-clicking the "**Perrot Satellite**" icon.

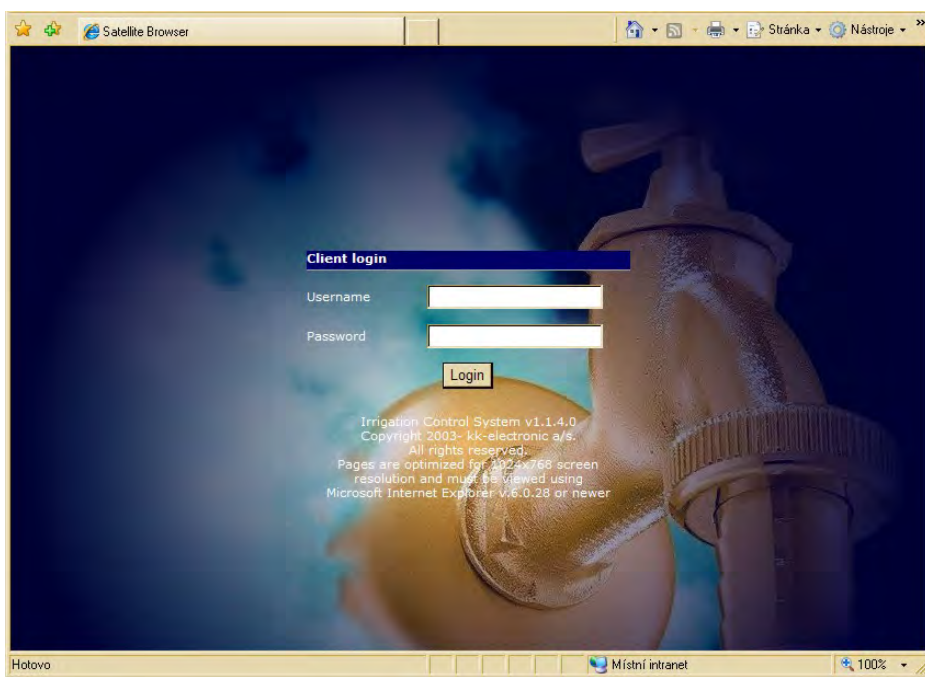

The browser opens the initial logon screen in which all users must key in their username and password.

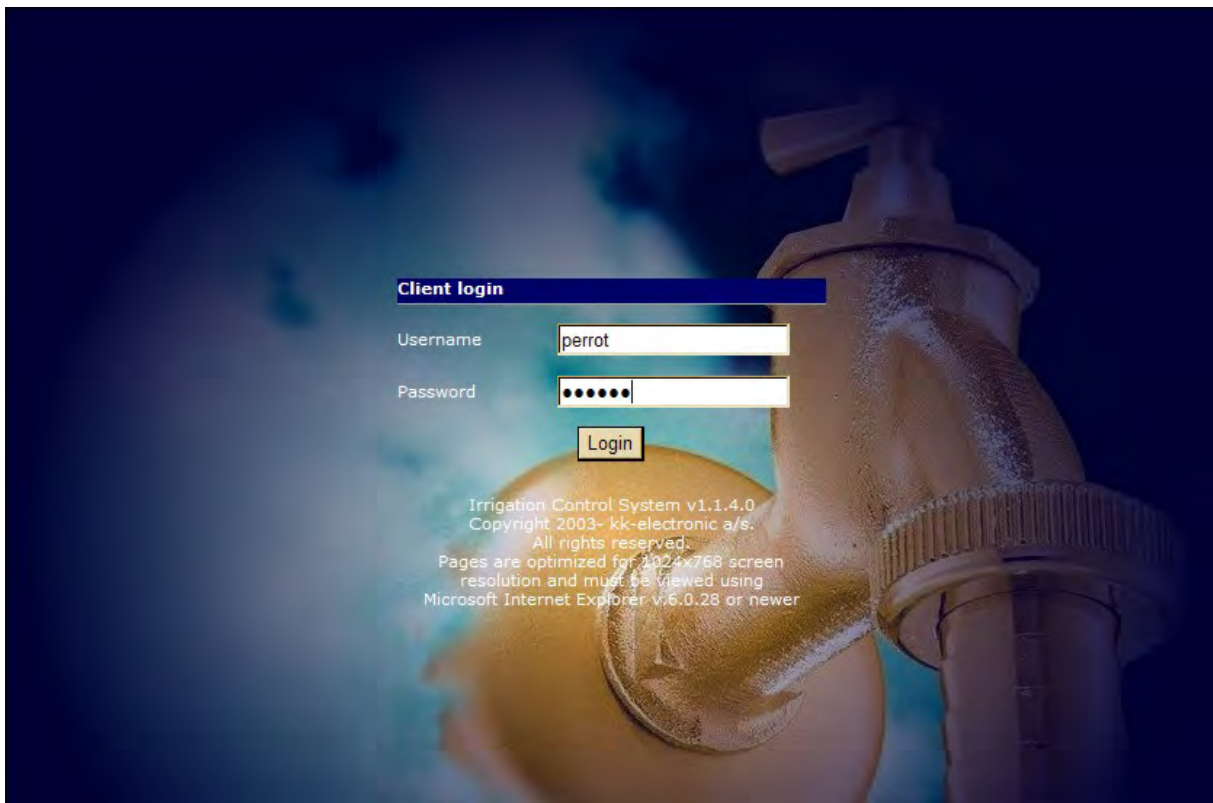

After the initial installation, the software has the following user with the administrator user rights pre-programmed:

- ✓ Username: Perrot
- ✓ Password: Perrot

Once logged-in the user can use *Perrot Satellite* without any limitations.

4.3 Creating a User



You need to have "technician" privileges to create a new user.

To create a new user, proceed as follows:

In the main menu:

1.	Setup
	User

Go to menu, **Setup > User**.



2.	
----	---

Enter a username.



Beware of capital/small letters (the username is case sensitive).

3.	
----	---

Enter a password.



Beware of capital/small letters (the password is case sensitive).

4.	User rights	↓
----	-------------	---

Choose a user type (privileges).

Select the required level of user rights for the newly created user in the **Privilege** combo box.



5.	New
----	-----

By clicking the **New** button you can save your newly created data and display it in the **Edit user** table.



If you want to protect the program from unauthorised access, delete the default "Perrot" user and create your own user with "technician" privileges.

4.4 Overview of Technician, Super-user and User Rights

The following table presents an overview of access rights granted to different users to access different menus:

Main menu	Submenu	Tab	User	Super-user	Technician	
Setup	Course	Courses		X	X	
		Valve collections		X	X	
		Valve collection		X	X	
		Settings		X	X	
	Satellites	Satellite			X	X
		Settings			X	X
	Hydraulics	Pump system			X	X
		Pumps			X	X
		Pump			X	X
		Groups			X	X
		Sectors			X	X
		Options			X	X
	Valves	Selection names			X	X
		Valves			X	X
		Valve			X	X
	Options	Control			X	X
		Emergency call			X	X
	User	User				X
Programs	Valves	Edit	X	X	X	
	Valve collections	Edit	X	X	X	
	Manual	Edit	X	X	X	
Irrigation	Schedule	Control	X	X	X	
		Edit	X	X	X	
		Single program	X	X	X	
	Surveillance	Overview	X	X	X	
		Details	X	X	X	
	Parameters	Edit	X	X	X	
Reports	Irrigation	Irrigation programs	X	X	X	
		Yearly	X	X	X	
		Snapshot	X	X	X	
Service	Satellite	General			X	
		Decoders			X	
		Decoder Test			X	
		Log			X	
		Programming			X	
	Error handling	Acknowledge			X	
	Application	Log			X	

4.5 Explanation of Screen Sections

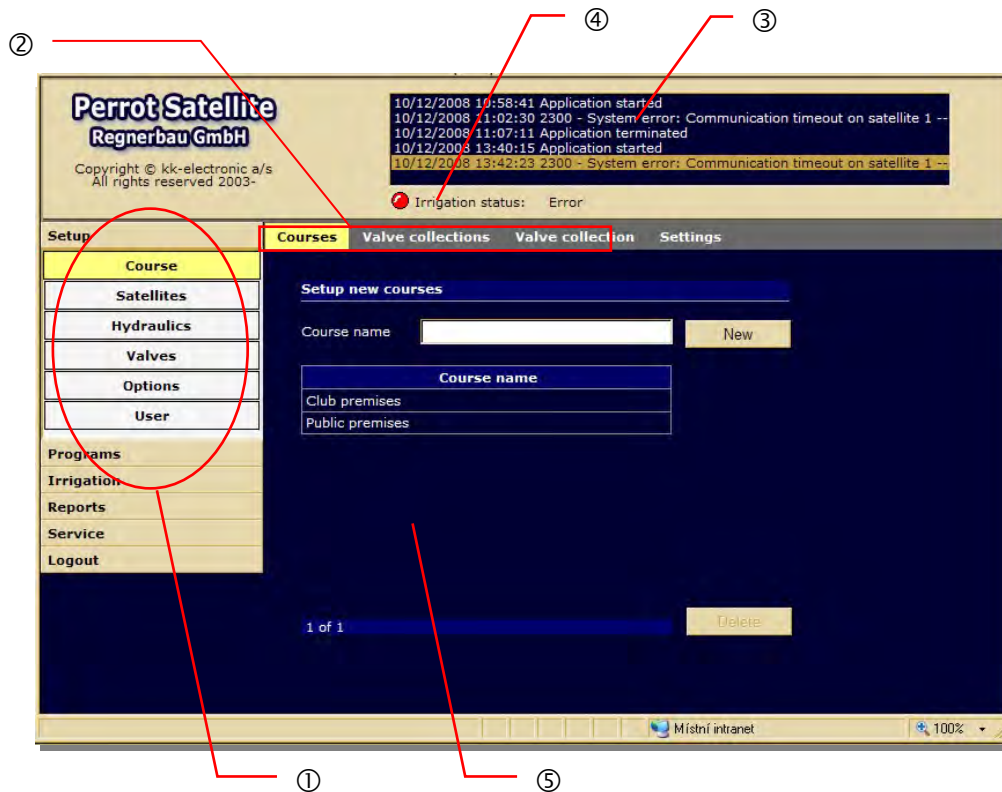

- ① Menu bar with the main menu and submenus
- ② Submenu tabs
- ③ System reports (log)
- ④ *Perrot Satellite* status line
- ⑤ Area for displaying and/or entering data

User Interface Description

- ① Menu bar with the main menu and submenus

You can open the main menu items by clicking them. The corresponding submenu will open for each of them.

Menus are grouped by their functions.

- ② Submenu tabs

Each submenu contains one or more tabs (representing screens) which are arrayed horizontally.

- ③ System reports (log)

This box lists all events generated by the program control, for example:

- ✓ Switching on and off different irrigation programs, decoders, pumps, etc.
- ✓ System errors such as communication errors, too high electrical current value, etc.
- ✓ Messages from the weather station and from all connected sensors.

④ *Perrot Satellite* status line

The following states can appear in the status line:

- ✓ Started: when the program is in the auto mode
- ✓ Active: when an irrigation program is running
- ✓ Stopped: when the auto mode is off
- ✓ Weather: if irrigation has been interrupted by the weather station
- ✓ Error: if an error has occurred

⑤ Area for displaying and/or entering data

The user interface itself in which the user can enter data, create irrigation programs and see entered or calculated values.



You can use the  function key (or the Full Screen button) while working with Satellite Browser. This will help you to see all the buttons and controls on each screen. (Please try this function to fully understand.)

5 Entering the Basic Data

5.1 Structuring a Project

The versatile *Perrot Satellite* structure provides an individual approach to entering your project and equipment data. The area to be irrigated can be divided from the point of view of the game (golf) or servicing. The user can decide whether to leave the whole area as one or whether to divide it into sub-areas to make it easier to work with.

Perrot Satellite offers dividing the area into up to 10 sub-areas and 10 pump systems, regardless of the irrigation programs running simultaneously or sequentially.

This division into sub-areas is crucial for the future control of the irrigation technology and for creation of irrigation programs. For this reason, we will explain the pros and cons of different alternatives – and use the following examples for clearer understanding.

You as the user need to have a clear idea of what you want to achieve before you start entering data and by this structuring the project.

Alternative 1



- ✓ All valves are assigned to only one area (course).
- ✓ All valves are fed from a single pump system (station).
- ✓ Different irrigation programs must run sequentially (not simultaneously).
- ✓ Example: a course with 9 or 18 holes and 1 pump station.
- ✓ This is the simplest alternative (identical with the previous Greenkeeper Win software).

Alternative 2

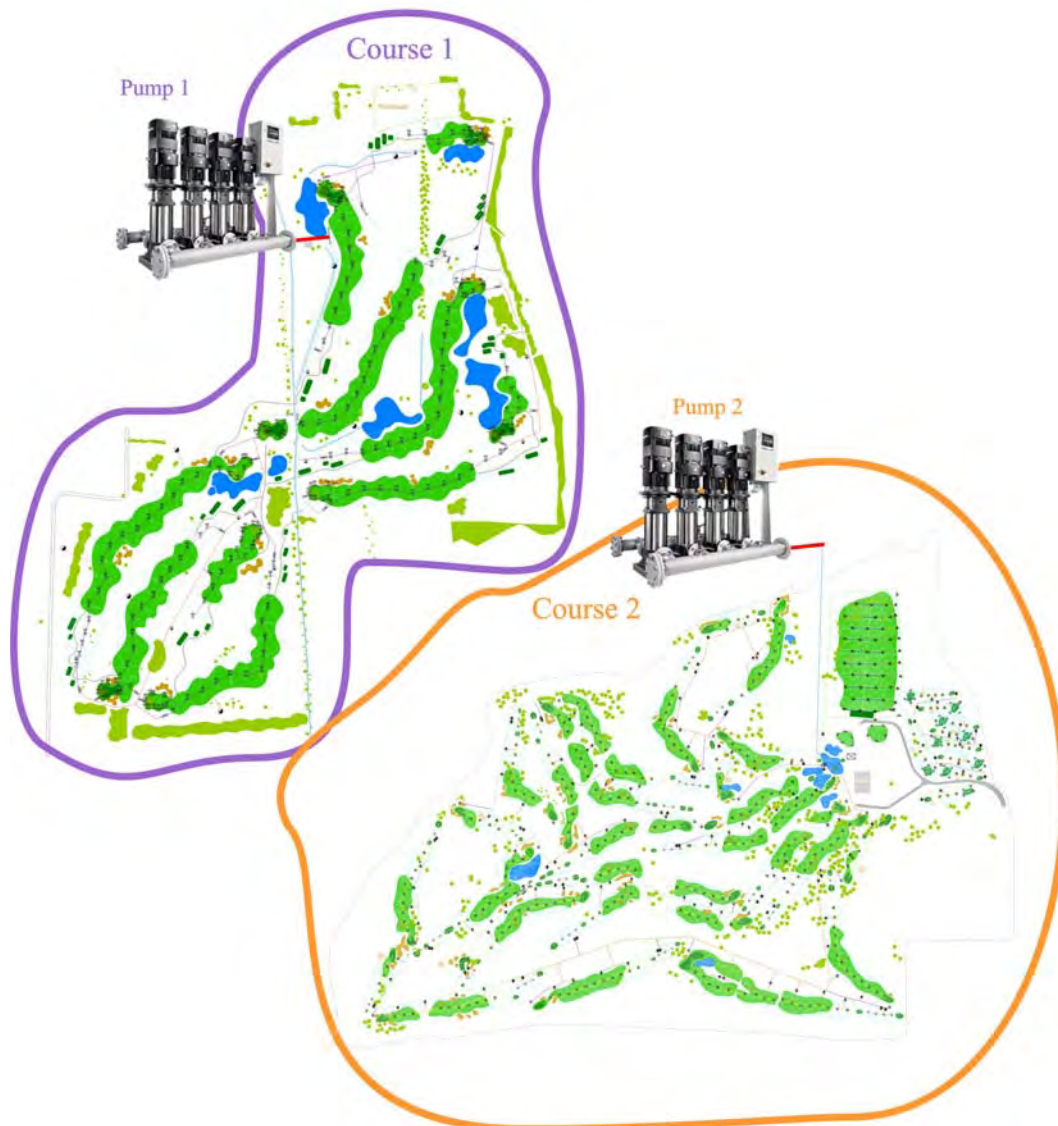

- ✓ Valves are divided into 2 courses (sub-areas).
- ✓ Each course is fed by its own pump system (station)
- ✓ Irrigation programs can run simultaneously for both courses
- ✓ Example: the existing 9/18-hole course has been extended by an additional 9/18-hole (hydraulically separate) course.

Alternative 3

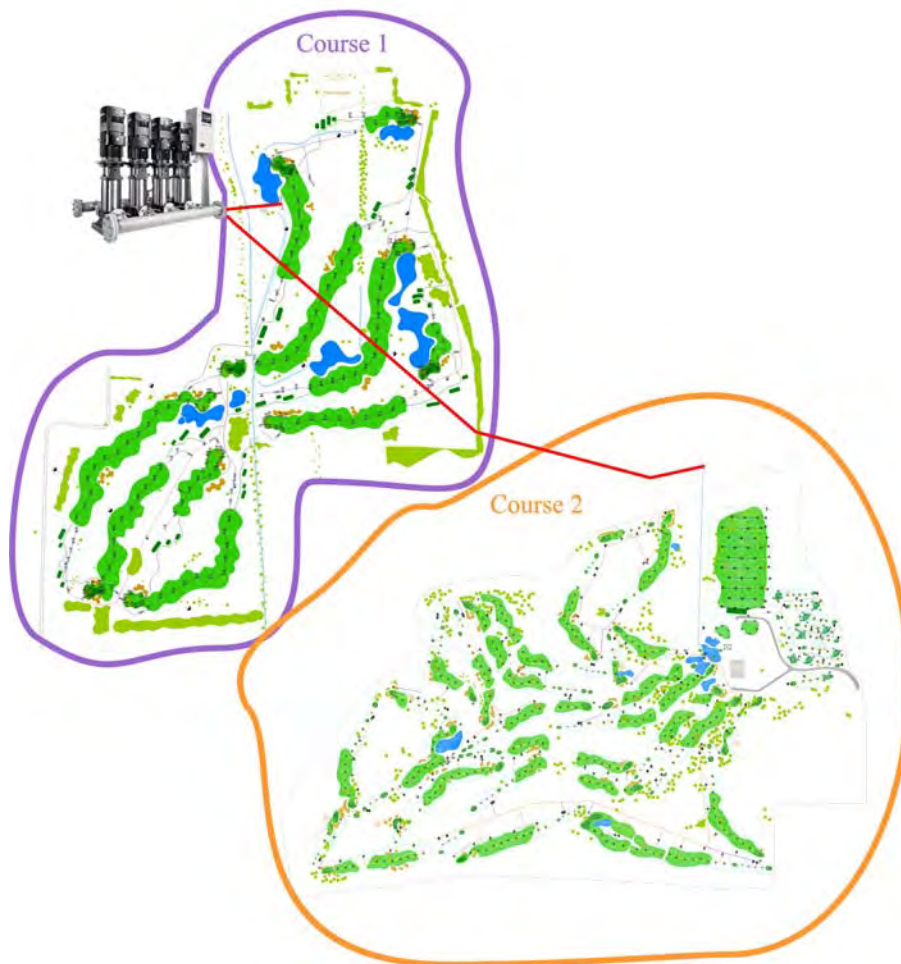

- ✓ Valves are divided into 2 courses (sub-areas).
- ✓ Both courses are fed by a shared pump system (station).
- ✓ Irrigation programs for different courses must run sequentially (not simultaneously).
- ✓ Example: the existing 9/18-hole course has been extended (and the pump system enlarged).

Advantage:

Valve data are easy to see as on one area

Disadvantage:

One piping line is not used => higher pressure loss



- ✓ Each area must have a pump system assigned to it.
- ✓ If more than 300 valves (decoders) are used, it is recommended to divide the area to make it easier to survey and control.
- ✓ The pump system can also be divided into 2 virtual systems to create smaller and easier-to-survey areas.
- ✓ In case of two or more hydraulically separate systems, it is recommended to divide the area into corresponding sub-areas. Only then will you be able to irrigate them simultaneously.

The number of areas (courses) is not dependant on the number of VCUs.

5.2 Entering the Irrigation Parameters

5.2.1 Irrigation Process

Based on the entered data, *Perrot Satellite* calculates suitable irrigation procedure and time. All needed commands are transferred via the PC serial port to the valve control unit (VCU). Once an irrigation program is activated, the VCU forwards these commands through a decoder to pumps and/or valves. The VCU also receives signals from sensors and forwards them to the control unit for further processing.



Further details concerning different components and their functioning will be explained later in this manual.

5.2.2 What Data Do I Need for the Program?

Before you start an irrigation program, you have to enter all necessary data concerning different components of the irrigation system. In order to do so, have manufacturer's data sheets for these components as well as a diagram with an overall view of the area to be irrigated available.



Enter only the original values as specified by the manufacturer!

The following data will be needed for individual system components:

Component	Parameter	Basic value	Note
Pump	Pump capacity m ³ /h		See the pump data sheet
	Pump identification		Pump name
	Decoder No.		Which decoder is the pump connected to?
	Bidirectional data flow?		Can the decoder send signals back to the pump?
	Satellite No.		Which VCU is the pump connected to?
	Efficiency in %		To what extend should the pump be used?
Valve	Flow in m ³ /h		See the valve data sheet
	Irrigated (covered) area in m ²		To be determined from the area irrigated by all connected sprinklers.
	Valve identification		Valve name
	Decoder No.		Which decoder is the valve connected to?
	Satellite-No.		Which VCU is the valve connected to?
	Bidirectional data flow?		Is the connected decoder bidirectional?
	Flow sensor?		Is the flow through the valve monitored by a sensor? The sensor may be installed at the sprinkler.

External Signal Providers

Component	Parameter	Basic value	Note
Sensor			

This documentation contains a component form in which all necessary data can be recorded.

Perrot Regnerbau Calw GmbH		Anlage:		Auftrags-Nr.:					
Industriestraße 19-29		Ort:		Bereich:					
D-75382 Althengstett		Betriebsmittelstückliste							
BMK = Betriebsmittelkennzeichen									
BMK Pos.	Geräte-Benennung	Stck	Hersteller / Norm	Type	techn. Daten Bestellnummer	zugehöriger Decoder	zugehöriger Satellite	gehört zu Pumpe/ System	Bemerkungen

5.2.3 Irrigated Area Example

To create a foundation for later entering, we will explain the procedure on this 1-hole training golf course example.

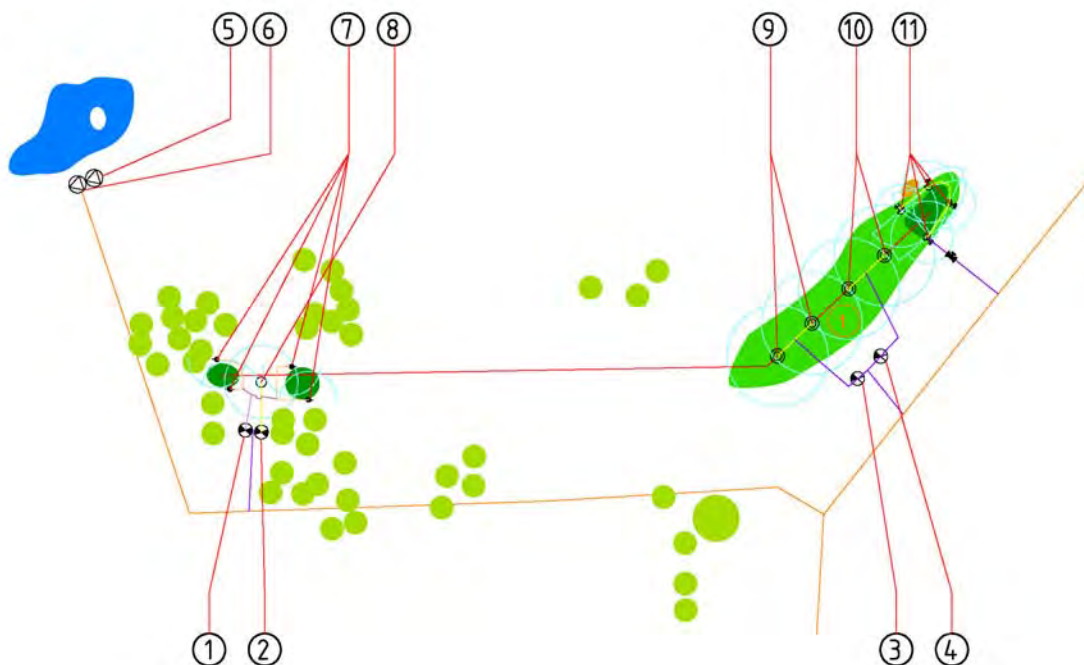

1-hole training course

The irrigation system has the following components installed:

Perrot Regnerbau Calw GmbH		Anlage: 1-Loch Übungsgolfplatz		Auftrags-Nr.: Perrot-1234-4					
Industriestraße 19-29		Ort: Golfhausen		Bereich: Loch 1					
D-75382 Althengstett		Betriebsmittelstückliste							
BMK Pos.	Geräte-Benennung	Stck	Hersteller / Norm	Type	techn. Daten Bestellnummer	zugehöriger Decoder	zugehöriger Satellite	gehört zu Pumpe/ System	Bemerkungen
Tee1/1 1	Magnetventil	1	Perrot	MVR 1"	1" - 12m ³ /h VMF5 50305	1	1 Master	Hy.Gr.: T+G Hy.Sec.: T Pumpenname	
8	Teilkreisversenkregner	4	Perrot	LVZA 22WH	Düse 4,5mm 500 m ² WW=14m Q=1,6m ³ /h P=5bar	1	1 Master		
Tee 1/2 2	Magnetventil	1	Perrot	MVR 1"	1" - 12m ³ /h VMF5 50305	2	1 Master	Hy.Gr.: T+G Hy.Sec.: T Pumpenname	
9	Vollkreisversenkregner	1	Perrot	LVZE 22H	Düse 8mm 200 m ² WW=19m Q=7,5m ³ /h P=5bar	2	1 Master		
FW 1/2 3	Magnetventil	1	Perrot	MVR 2"	2" - 28m ³ /h VMH5 50306	3	1 Master	Hy.Gr.: FW Hy.Sec.: FW Pumpenname	
10	Vollkreisversenkregner	6	Perrot	LVZR 22	Düse 12mm 5500 m ² WW=28m Q=14m ³ /h P=5bar	3	1 Master		
FW 1/1 4	Magnetventil	1	Perrot	MVR 2"	2" - 28m ³ /h VMH5 50306	4	1 Master	Hy.Gr.: FW Hy.Sec.: FW Pumpenname	
11	Vollkreisversenkregner	6	Perrot	LVZR 22	Düse 12mm 5500 m ² WW=28m Q=14m ³ /h P=5bar	4	1 Master		
G 1 5	Magnetventil	1	Perrot	MVR 1½"	1½" - 20m ³ /h VM5 50307	5	1 Master	Hy.Gr.: T+G Hy.Sec.: G Pumpenname	Bidirectional
12	Teilkreisversenkregner	4	Perrot	LVZE 22WDH	Düse 6mm 600 m ² WW=18m Q=5m ³ /h P=5bar	5	1 Master		
CR 16-10 6	Pumpe	1	Grundfos	CR 16-10	16 m ³ /h	200	1 Master		Bidirectional
CR 8-10 7	Pumpe	1	Grundfos	CR 8-10	8 m ³ /h	201	1 Master		

5.2.4 Activation of Hydraulic Groups and Sectors

During irrigation, the software tries to open as many valves as allowed by the pump capacity. This opening takes place according to an algorithm which considers only the flows of individual valves, not the arrangement of the irrigation piping.

For the best calculated results, it is therefore important to divide the distribution piping network into hydraulic groups and sectors. Based on this information, the software can use the whole piping network and the full capacity of connected pumps in the optimum way.

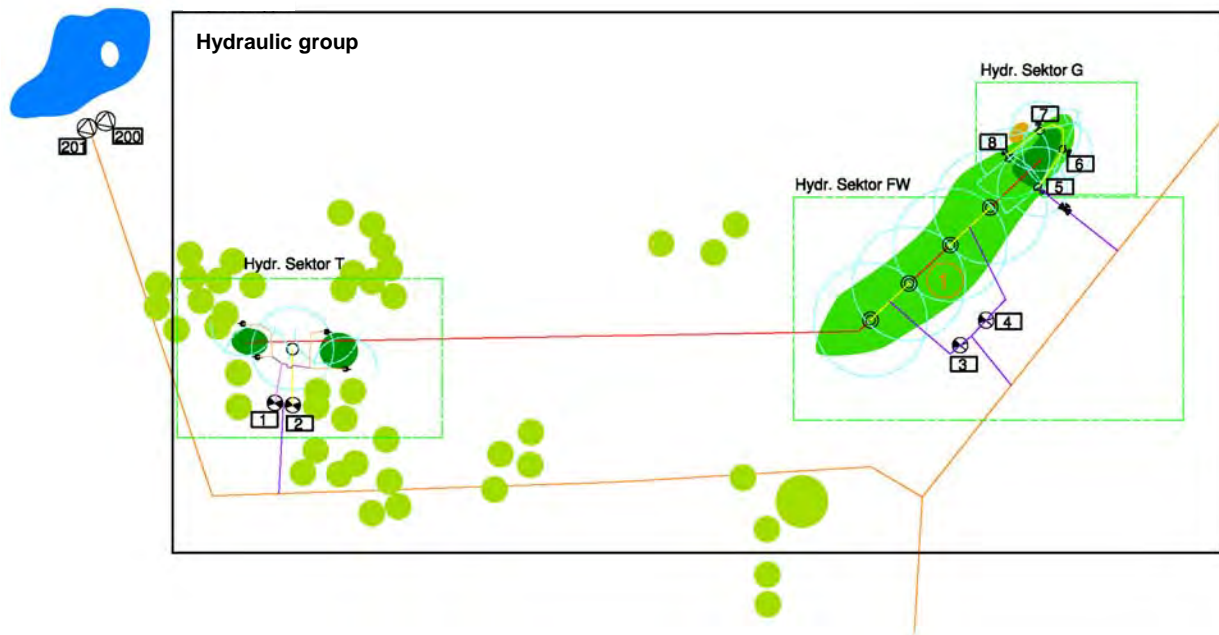

Let us use this data in the *Perrot Satellite* software.

5.3 Dividing the Area into Courses

Irrigation of several different areas (such as sport grounds, parks or golf courses) can be controlled from a single PC. As mentioned in chapter 5.1, the total area to be irrigated can be divided into various sub-areas.

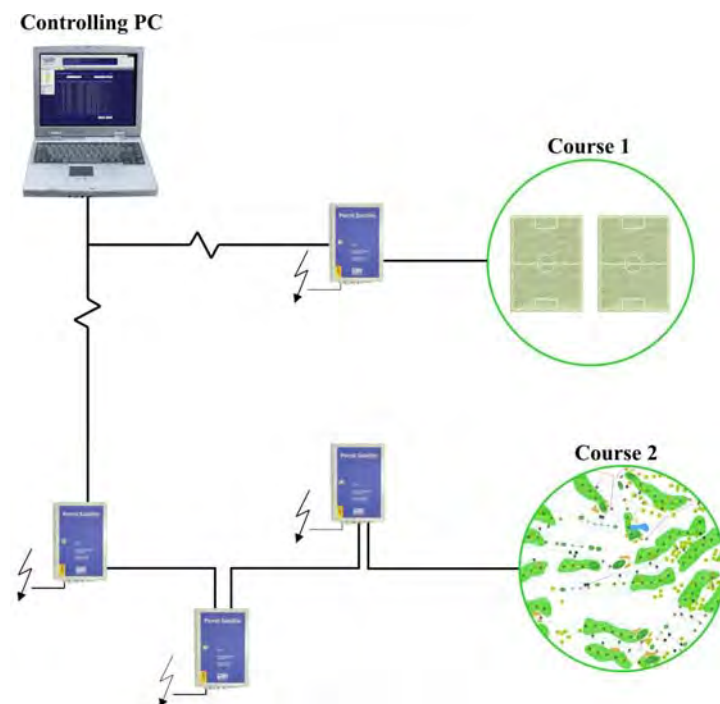





You must have the "technician" privileges to create a new course.

To create a new area (course), proceed as follows:

In the Setup menu:

- | | | |
|----|--------|----------------------------------|
| 1. | Course | Go to the Course submenu. |
|----|--------|----------------------------------|



- | | | | |
|----|---|---|--|
| 2. | Course name |  | Click the Course name data field. |
| 3. |  |  | Key in the name of the area (course).
For ideas for structuring see chapter 5.1. <i>Structuring a Project</i> . |
| 4. | New |  | Click the New button. |



Now we will enter all values and parameters for components of this area (course).

5.4 Creating Satellites

The valve controlling unit (VCU) transfers messages from the PC to connected actuators. At the same time, it also receives data from connected sensors and decoders. This means it works as a communication satellite between the controlling unit and the actuators/sensors.



One link can include up to 9 satellites (VCUs).

To create a new satellite, proceed as follows:

In the Setup menu:

- | | | |
|----|------------|--------------------------------------|
| 1. | Satellites | Go to the Satellites submenu. |
|----|------------|--------------------------------------|

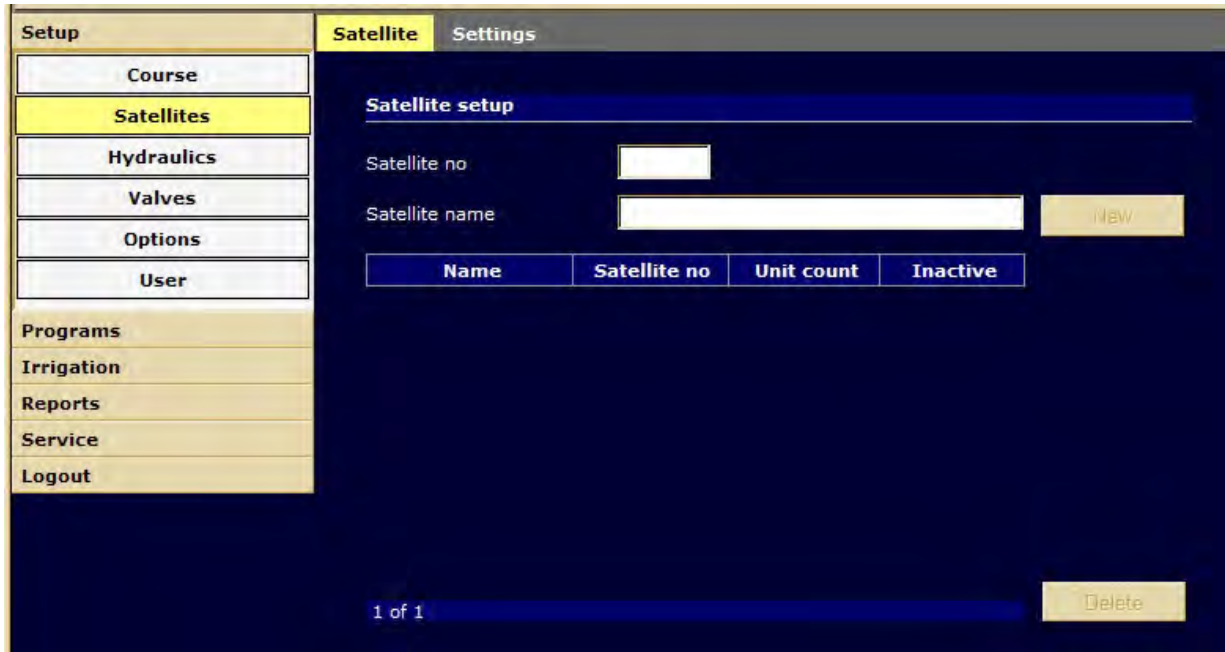

- | | | | |
|----|--------------------------|--|--|
| 2. | Satellite No. | | Click the Satellite no data field. |
| 3. | | | Key in the required satellite number. |
| 4. | Satellite identification | | Click the Satellite name data field. |
| 5. | | | Key in the required satellite name (the place of the VCU installation, for example). |
| 6. | New | | Click the New button. |

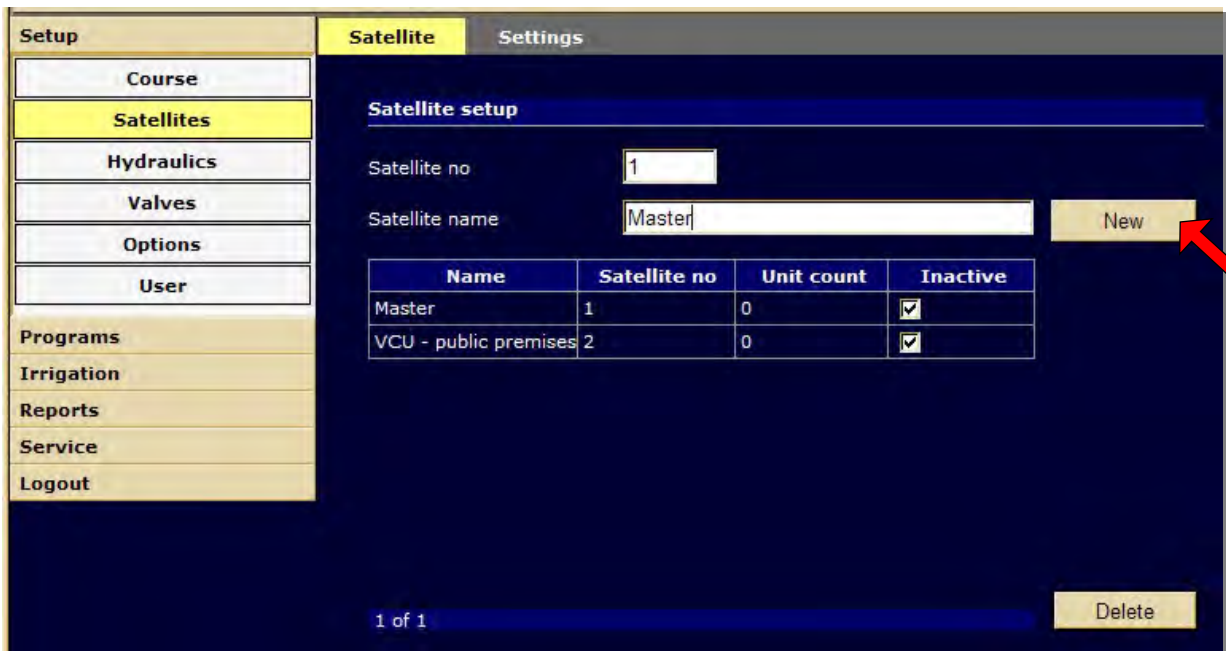

Name	Satellite no	Unit count	Inactive
Master	1	0	<input checked="" type="checkbox"/>
VCU - public premises	2	0	<input checked="" type="checkbox"/>



If there is no connection established between the PC and the VCU, the **inactive** tick box must be ticked.

This tick box must be ticked also before uploading new software to the VCU (update) – see chapter 3.5.

5.5 Creating Pump Data

Each course must have a pump system assigned to it. Each pump system can contain up to 9 pumps controlled by *Perrot Satellite*.



To create a new pump system, proceed as follows:

In the **Setup** menu:

- | | | |
|----|------------|--------------------------------------|
| 1. | Hydraulics | Go to the Hydraulics submenu. |
|----|------------|--------------------------------------|



- | | | | |
|----|------------------|--|--|
| 2. | Pump system name | | Click the Pumpsystem name data field. |
|----|------------------|--|--|

- | | | |
|----|--|--|
| 3. | | Key in the required name for your pump system (pumping station). |
|----|--|--|

- | | | | |
|----|-----|--|------------------------------|
| 4. | New | | Click the New button. |
|----|-----|--|------------------------------|

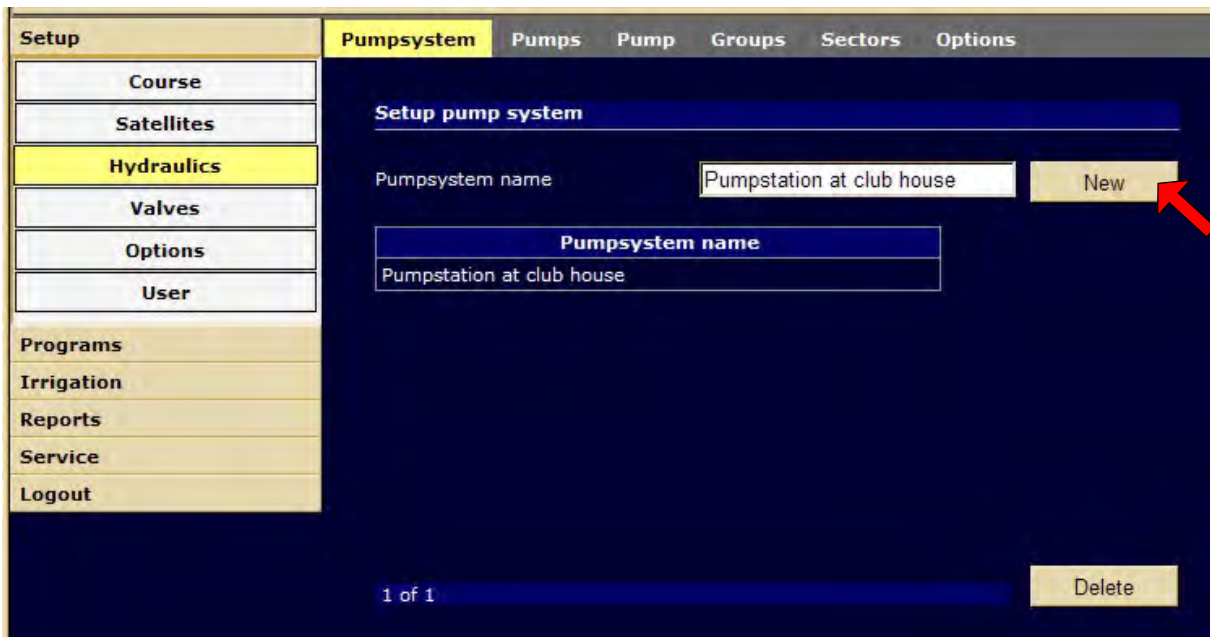

- | | | |
|----|-------|--|
| 5. | Pumps | Go to the Pumps screen by double-clicking the newly created pump system in the table or |
|----|-------|--|

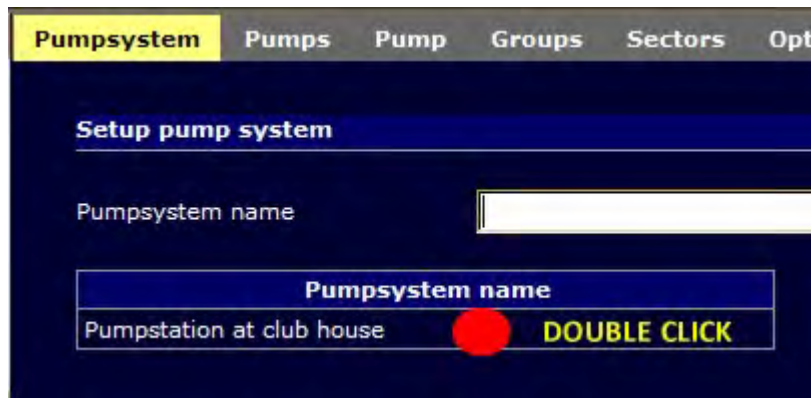

by clicking the **Pumps** tab.

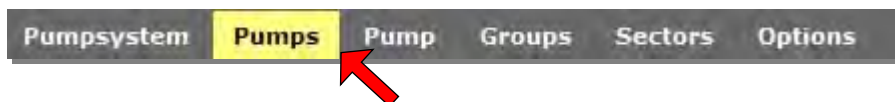

- | | | |
|----|-------|--|
| 6. | Pumps | Please make sure you have selected the correct pump system. (Modify your selection if needed.) |
|----|-------|--|

Setup Course Satellites Hydraulics Valves Options User Programs Irrigation Reports Service Logout	Pumpsystem Pumps Pump Groups Sectors Options
	Pumpsystem selection
	Pumpsystem <input type="text" value="Pumpstation at club hc"/>
	Setup new pump
	Pump name <input type="text"/>
	Pump flow (m ³) <input type="text"/> <input type="button" value="New"/>
	<input type="button" value="Pump name"/> <input type="button" value="Pump flow (m<sup>3</sup>/h)"/>
	<input type="button" value="Print"/>
	1 of 1 <input type="button" value="Delete"/>

Creating a pump:

- | | | | |
|-----|-------------------------------|--|---|
| 7. | Pump name | | Click the Pump name data field. |
| 8. | | | Key in the required name of the pump. |
| 9. | Pump flow (m ³ /h) | | Click the Pump flow data field. |
| 10. | | | Key in the corresponding pump flow (capacity) in m ³ /h. |
| 11. | New | | Click the New button. This will save the pump and its capacity. Repeat this procedure for all other pumps of the same pump system. |



If you want this pump system to be controlled autonomously (i.e. through pressure or frequency), you can key in only the total pumping capacity and do not have to create individual pumps.

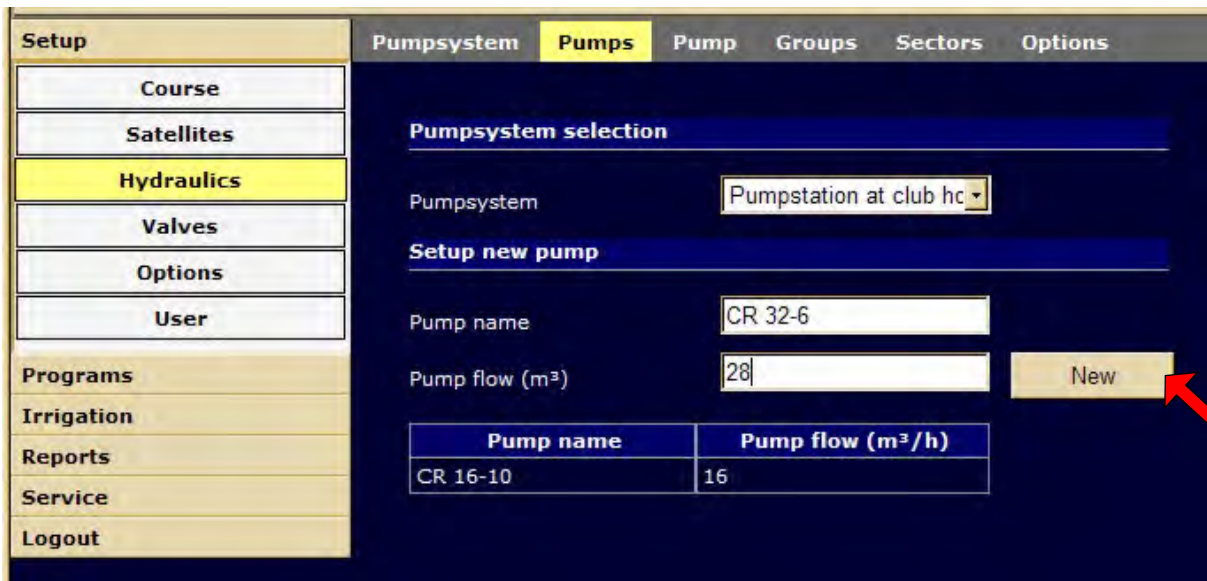

12. Pump

Go to the **Pump** screen by double-clicking the newly created pump in the table or

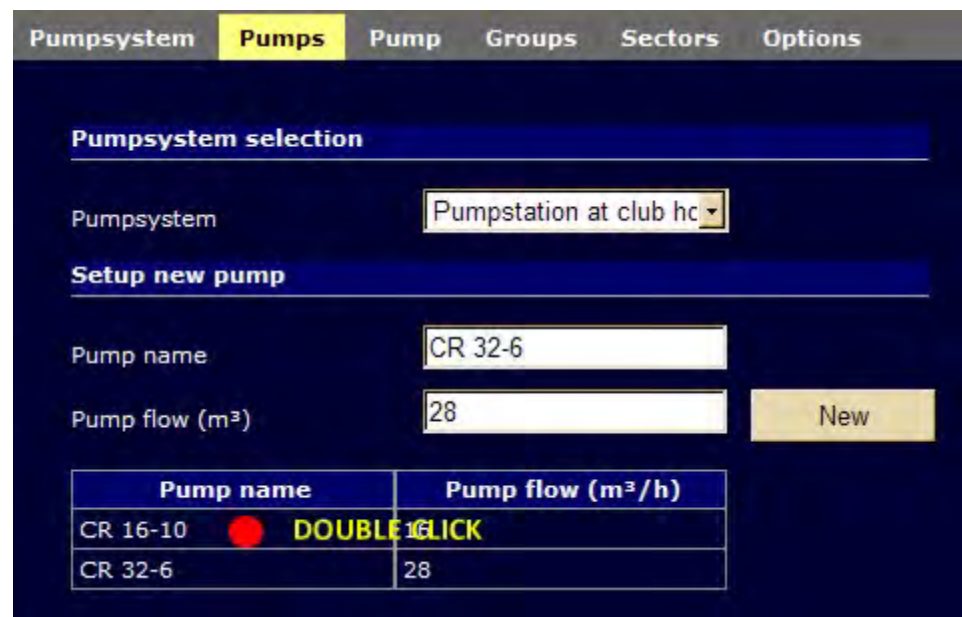





by clicking the **Pump** tab.

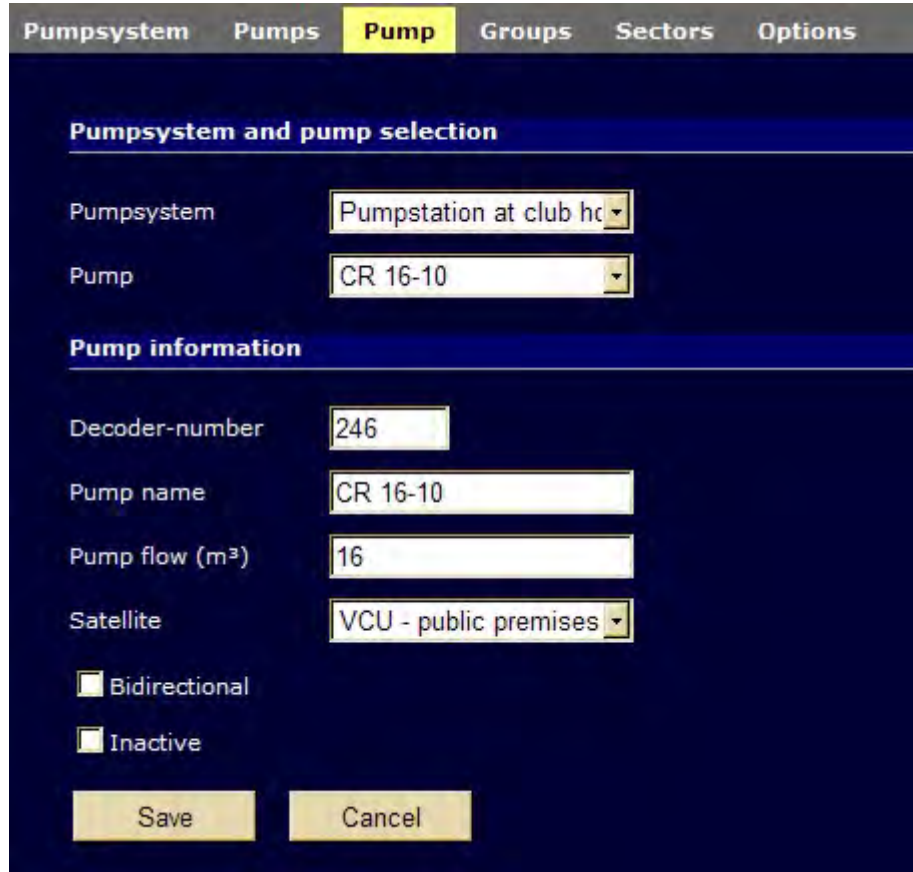

13.	Pump	Please make sure you have selected the correct pump system and correct pump (modify your selection if needed) and specify parameters for your pump.
-----	------	---



14.	Decoder number		Click the Decoder-number data field.
15.			Key in the number of the decoder which will switch the pump on and off.
16.	Satellite		Choose the satellite to which the decoder will be connected.
17.	Bidirectional Inactive		Tick the applicable pump characteristics.



Bidirectional:

If the connected decoder is capable of bidirectional operation.

Inactive:

If the pump is installed but currently not used.

The software will then count with the pump capacity.

18.	Save		Click the Save button.
-----	------	---	-------------------------------

Setup	Pumpsystem	Pumps	Pump	Groups	Sectors	Options
Course						
Satellites						
Hydraulics	Pumpsystem and pump selection					
Valves	Pumpsystem	Pumpstation at club hc				
Options	Pump	CR 16-10				
User	Pump information					
Programs	Decoder-number	246				
Irrigation	Pump name	CR 16-10				
Reports	Pump flow (m³)	16				
Service	Satellite	VCU - public premises				
Logout	<input type="checkbox"/> Bidirectional <input type="checkbox"/> Inactive					
		Save		Cancel		

19. Pump Repeat this procedure for all other pumps.



If you fail to save your data by clicking the **Save** button, you will lose all the keyed-in data with the exception of the data set keyed-in last.

5.6 Hydraulic Groups and Sectors



The software always tries to open as many valves as allowed by the pump capacity during irrigation.

If the valves are not assigned to any hydraulic group/sector, the software uses its own algorithm considering the flows of individual valves, but not the arrangement and dimensioning of the piping system.

If two or more simultaneously operating valves are fed from the same piping branch, the overall irrigation efficiency may be negatively affected (pressure drop). In order to avoid this, please enter information in *Perrot Satellite* concerning which valves should be fed from which piping branch and the maximum allowed flow through different piping branches.

By dividing the piping network into hydraulic groups and/or sectors, *Perrot Satellite* can use the whole distribution system in the optimum way and adjust the best pressure settings at different irrigation stations.

Please calculate the maximum flow based on the piping network diameters and lengths.

Creating Hydraulic Groups:

- | | | | |
|----|----------------------|--|---|
| 1. | Groups | | Click the Groups tab. |
| 2. | Pump system | | Choose the required pump system in the combo-box. |
| 3. | Hydraulic group name | | Click the Hydraulic group name data field. |
| 4. | | | Key in the required name for your hydraulic group. |
| 5. | Max. group flow. | | Click the Group flow data field. |
| 6. | | | Key in the maximum flow (hydraulic capacity) of the hydraulic group in m ³ /h. |
| 7. | New | | To save the entered values, click the New button. |



Acceptable values: **0 - 999 m³/h**
The water consumption in any hydraulic group must not exceed the capacity (flow) of the feeding pump(s).

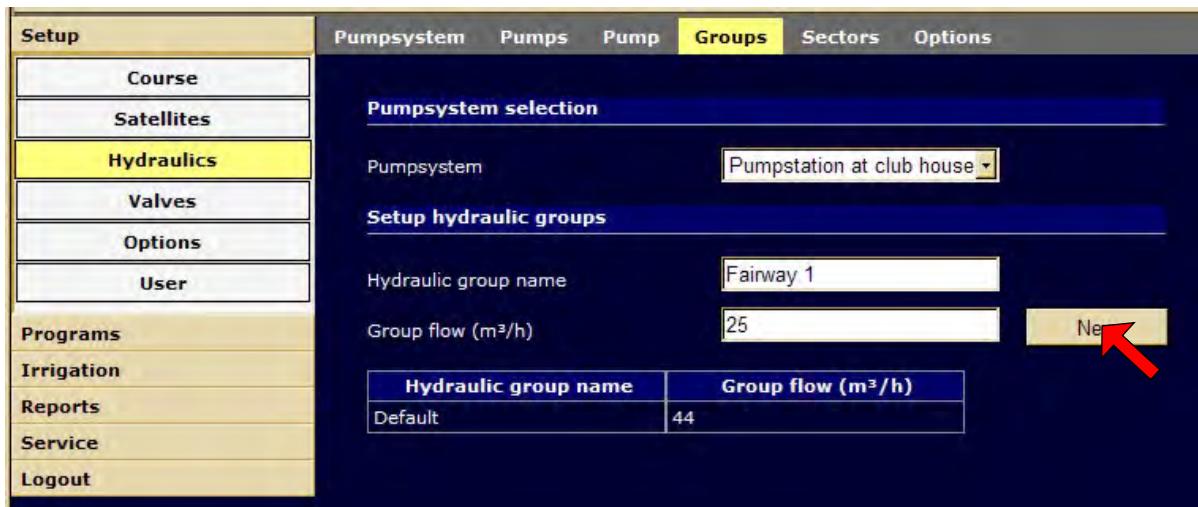







- | | | | |
|----|--------|--|---|
| 8. | repeat | | Repeat this procedure for all other hydraulic groups. |
|----|--------|--|---|

Creating Hydraulic Sectors:



Hydraulic sectors are actually "sub-groups" of the hydraulic groups.
Each hydraulic sector is part of a hydraulic group.

- | | | | |
|-----|-------------|--|---|
| 9. | Sectors | | Click the Sectors tab. |
| 10. | Pump system | | Select the required pump system from the Pumpsystem combo-box. |

- | | | | |
|-----|---|---|---|
| 11. | Hydraulic group |  | Select the required pump system from the Pumpsystem combo-box. |
| 12. | Hydraulic sector name |  | Click the Hydraulic sector name data field. |
| 13. |  | | Key in the required name of your hydraulic sector. |
| 14. | Max. sector flow |  | Click the Sector flow data field. |
| 15. |  | | Key in the maximum sector flow value in m ³ /h. |
| 16. | New |  | To save the entered values, click the New button. |

The flow in any hydraulic sector depends on the flow of its superior hydraulic group. It must not exceed the total capacity of the corresponding feeding pumps or the flow of the superior hydraulic group. Acceptable values: **0 - 999 m³/h**
Several sectors can be assigned to one hydraulic group. The actual assignment is done as part of entering the valve data.

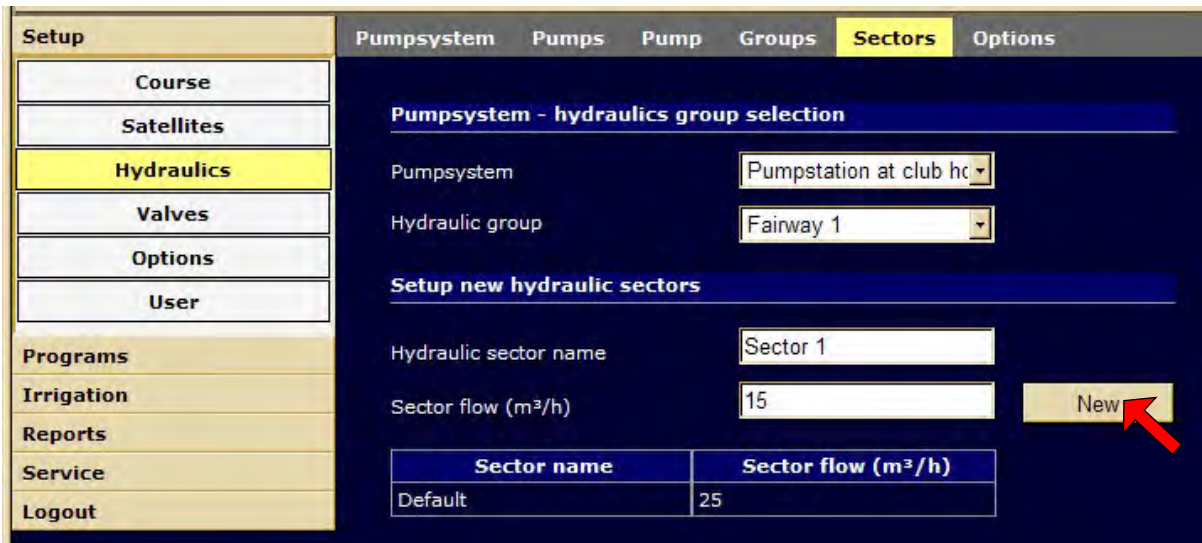

Sector name	Sector flow (m ³ /h)
Default	25

- | | | |
|-----|--------|--|
| 17. | repeat | Repeat this procedure for all other hydraulic sectors. |
|-----|--------|--|

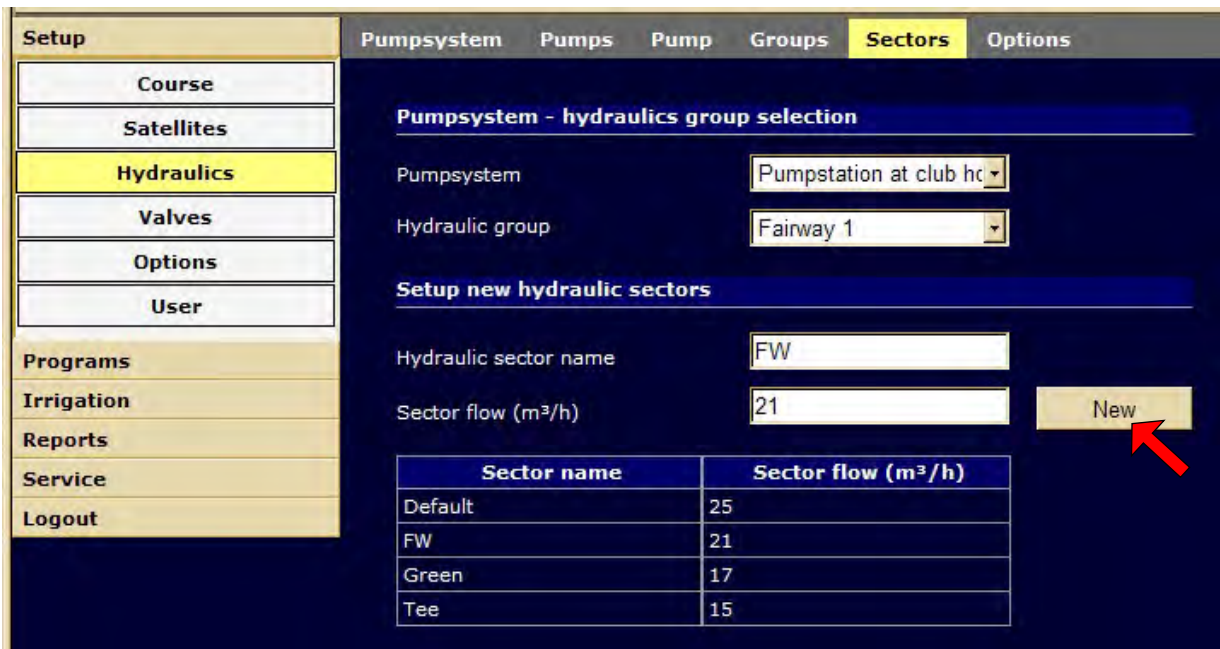

Setup

Course
Satellites
Hydraulics
Valves
Options
User

Programs
Irrigation
Reports
Service
Logout

Pumpsystem Pumps Pump Groups **Sectors** Options

Pumpsystem - hydraulics group selection

Pumpsystem Pumpstation at club hc
Hydraulic group Fairway 1

Setup new hydraulic sectors

Hydraulic sector name FW
Sector flow (m³/h) 21 **New**

Sector name	Sector flow (m³/h)
Default	25
FW	21
Green	17
Tee	15

5.7 Selection Names





Each valve can (but does not have to) have a selection name assigned to it to simplify valve searching and sorting. This name simplifies the creation of irrigation programs and/or searching for a particular valve in other menus. Assigning a selection name to a valve is specially important if a large number of valves is used within a system.

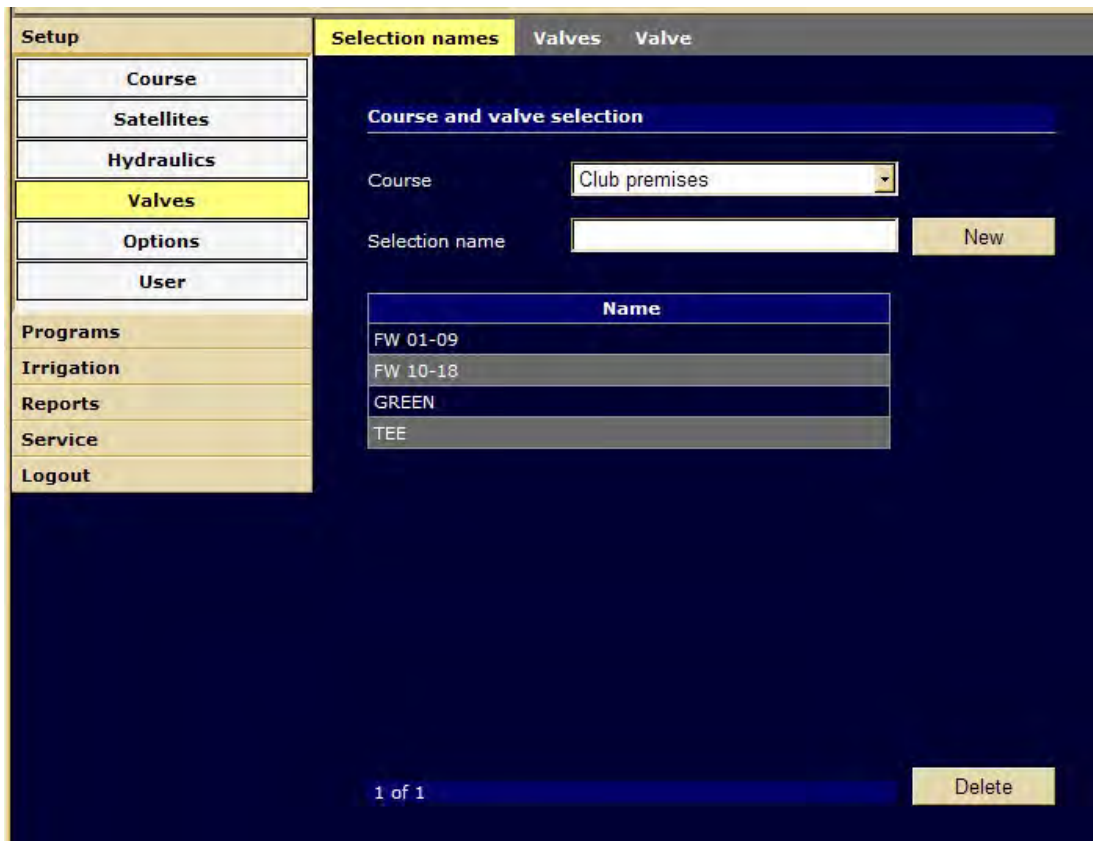

The selection name should be a collective name describing several valves assigned to the selection.



Creating Selection Names:

- | | | | |
|----|---|---|--|
| 1. | Course |  | Choose the required course in the Course combo-box. |
| 2. | Selection name |  | Click the Selection name data field. |
| 3. |  | | Key in the required name for your selection. |
| 4. | New |  | To save the entered name, click the New button. |
| 5. | Name | | The new selection name will be displayed in the Name table. |



New selection names can be added and existing names deleted at any time.

5.8 Valve Data

In the **Valves** submenu, **Valve** tab, each valve is given a name and is assigned to a pump system, a satellite, a hydraulic group a sector and a decoder. In addition to these, the corresponding area to be covered by the valve and its flow must be specified for each valve.



These values are to be determined by the installation technician during valve installation. The more accurate these data are, the better irrigation results can be achieved.

Enter the valve values in the following way:

In the Setup menu:

1.	Valve	Go to the Valves > Valve menu. All valve values are entered and saved on this screen.
----	-------	---

2.	Course		Choose the required course in the Course combo-box.
----	--------	--	--

3.	Entering valve values		Click the New button.
----	-----------------------	--	------------------------------

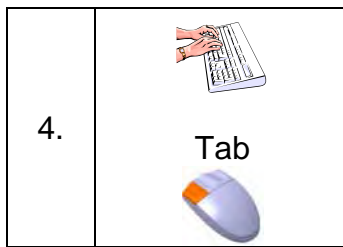

Enter all the valve data starting with the decoder number. Use the Tab key to move to the next data field or click the required field with the mouse. Enter the **Valve name**, **Area covered** and **Flow** in the corresponding fields.

Values and their ranges:

- ✓ Flow: 0÷999 m³/h
- ✓ Area covered: 0÷99999 m²

Possible abbreviations for valves:

- T = Tee
- B = Bunker
- D = Driving Range
- FW = Fairway
- G = Green
- P = Pitching Green
- R = Practice Area
- WW = Walkways

Example:

G	01	-	1	
				Sequential valve No.
Green	Hole No.			



The software lists valves in alphabetical order. You can influence the order of their appearance by assigning certain systematic names to them.

Names not recommended:
names:

G1
G10
G11
G12
:
:
G18
G2
G3

Recommended

G01
G02
:
G09
G10
G11
:
:
G18

- ✓ Use decoder numbers 1-230 for controlling the valves.
- ✓ Use decoder numbers 230-244 for controlling the pumps.
- ✓ The decoder number 245 has been reserved for reporting (feeding back) in case of a pump system error.
- ✓ Decoder numbers 246-255 should not be used, but rather left as a reserve.



Setup	Selection names	Valves	Valve
Course	Course and valve selection		
Satellites	Course	Club premises	
Hydraulics	Valve name	FW 01-1	Delete
Valves	Valve		
Options	New	Decoder-number	176
User		Valve name	FW 01-1
Programs		Selection Name	FW 01-09
Irrigation		Area covered (m ²)	666
Reports		Flow (m ³ /h)	27
Service			
Logout			

Then the valve has to be assigned to **Selection (name)**, a **Pump system**, a **Hydraulic group**, a **Hydraulic sector**, a **Destination course** and to a **Controlling satellite**. The assignments are done in the corresponding combo-boxes. Use the mouse to choose/open a combo-box and to select a value from its drop-down list.

Pumpsystem	Pumpstation at club hou
Hydraulic group	Default
Hydraulic sector	Default
Destination course	Club premises
Controlling satellite	Master

Bidirectional Flow sensor	<input type="checkbox"/>
---------------------------	--------------------------

Choose the additional characteristics by ticking the corresponding tickbox.

Save	<input type="button" value="Save"/>
------	-------------------------------------

To save the entered values, click the **Save** button.

<input type="checkbox"/> Bidirectional	<input type="button" value="Save"/>	<input type="button" value="Cancel"/>
<input type="checkbox"/> Flowsensor		



Tick the **Bidirectional** tickbox if the installed decoder is of the bidirectional type. Such a decoder can send information back to the VCU.
 Tick the **Flowsensor** tickbox if the installed valve is a magnetic valve with a sensor and is controlled by a bidirectional decoder.
 This function provides feedback on the valve status and sends it to the VCU. It can only be used in combination with the **Bidirectional** function.

5.	repeat
----	--------

Repeat this procedure for all the remaining valves.

Setup	Selection names	Valves	Valve																																																						
Course	<div style="background-color: #002060; color: white; padding: 5px;">Course and valve selection</div> <p>Course name: <input type="text" value="Club premises"/> Valve name: <input type="text"/> <input type="button" value="Search"/></p> <table border="1" style="width: 100%; border-collapse: collapse; text-align: center;"> <thead> <tr style="background-color: #002060; color: white;"> <th>Satellite</th> <th>Decoder</th> <th>Valve name</th> <th>Selection</th> <th>Pumpsystem</th> <th>Group</th> <th>Sector</th> <th>Area (m²)</th> <th>Flow (m³/h)</th> </tr> </thead> <tbody> <tr> <td>1</td> <td>1</td> <td>FW 01-1</td> <td>FW 01-09</td> <td>Pumpstation at clu</td> <td>Hole 1</td> <td>FW</td> <td>666</td> <td>27</td> </tr> <tr> <td>1</td> <td>2</td> <td>FW 01-2</td> <td>FW 01-09</td> <td>Pumpstation at clu</td> <td>Hole 1</td> <td>FW</td> <td>500</td> <td>20</td> </tr> <tr> <td>1</td> <td>3</td> <td>Tee 01-1</td> <td>FW 01-09</td> <td>Pumpstation at clu</td> <td>Hole 1</td> <td>T</td> <td>250</td> <td>12</td> </tr> <tr> <td>1</td> <td>4</td> <td>Tee 01-2</td> <td>FW 01-09</td> <td>Pumpstation at clu</td> <td>Hole 1</td> <td>T</td> <td>250</td> <td>12</td> </tr> <tr> <td>1</td> <td>5</td> <td>G 01-1</td> <td>FW 01-09</td> <td>Pumpstation at clu</td> <td>Hole 1</td> <td>G</td> <td>600</td> <td>8</td> </tr> </tbody> </table>			Satellite	Decoder	Valve name	Selection	Pumpsystem	Group	Sector	Area (m ²)	Flow (m ³ /h)	1	1	FW 01-1	FW 01-09	Pumpstation at clu	Hole 1	FW	666	27	1	2	FW 01-2	FW 01-09	Pumpstation at clu	Hole 1	FW	500	20	1	3	Tee 01-1	FW 01-09	Pumpstation at clu	Hole 1	T	250	12	1	4	Tee 01-2	FW 01-09	Pumpstation at clu	Hole 1	T	250	12	1	5	G 01-1	FW 01-09	Pumpstation at clu	Hole 1	G	600	8
Satellite				Decoder	Valve name	Selection	Pumpsystem	Group	Sector	Area (m ²)	Flow (m ³ /h)																																														
1				1	FW 01-1	FW 01-09	Pumpstation at clu	Hole 1	FW	666	27																																														
1				2	FW 01-2	FW 01-09	Pumpstation at clu	Hole 1	FW	500	20																																														
1				3	Tee 01-1	FW 01-09	Pumpstation at clu	Hole 1	T	250	12																																														
1				4	Tee 01-2	FW 01-09	Pumpstation at clu	Hole 1	T	250	12																																														
1				5	G 01-1	FW 01-09	Pumpstation at clu	Hole 1	G	600	8																																														
Satellites																																																									
Hydraulics																																																									
Valves																																																									
Options																																																									
User																																																									
Programs																																																									
Irrigation																																																									
Reports																																																									
Service																																																									
Logout																																																									

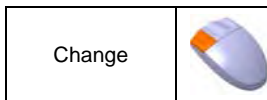

Names and/or values of valves can be changed by going to the **Valves** submenu, clicking the **Valves** tab and double-clicking the line of the valve to modify.

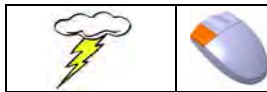

These changes will be accepted by the software only after you click the **Save** button.

5.9 Options (Pump Management)

5.9.1 Switching Pumps On/Off by Program Start/End

If more pumps are connected through a decoder, you can control them through the pump management options. You can:

- switch them on/off
- connect/disconnect them

so that the pumps are used in the optimum way for the irrigation process. You can also manually control valves.



You need to have Administrator rights to enter your data.

Example – Operation with pump management

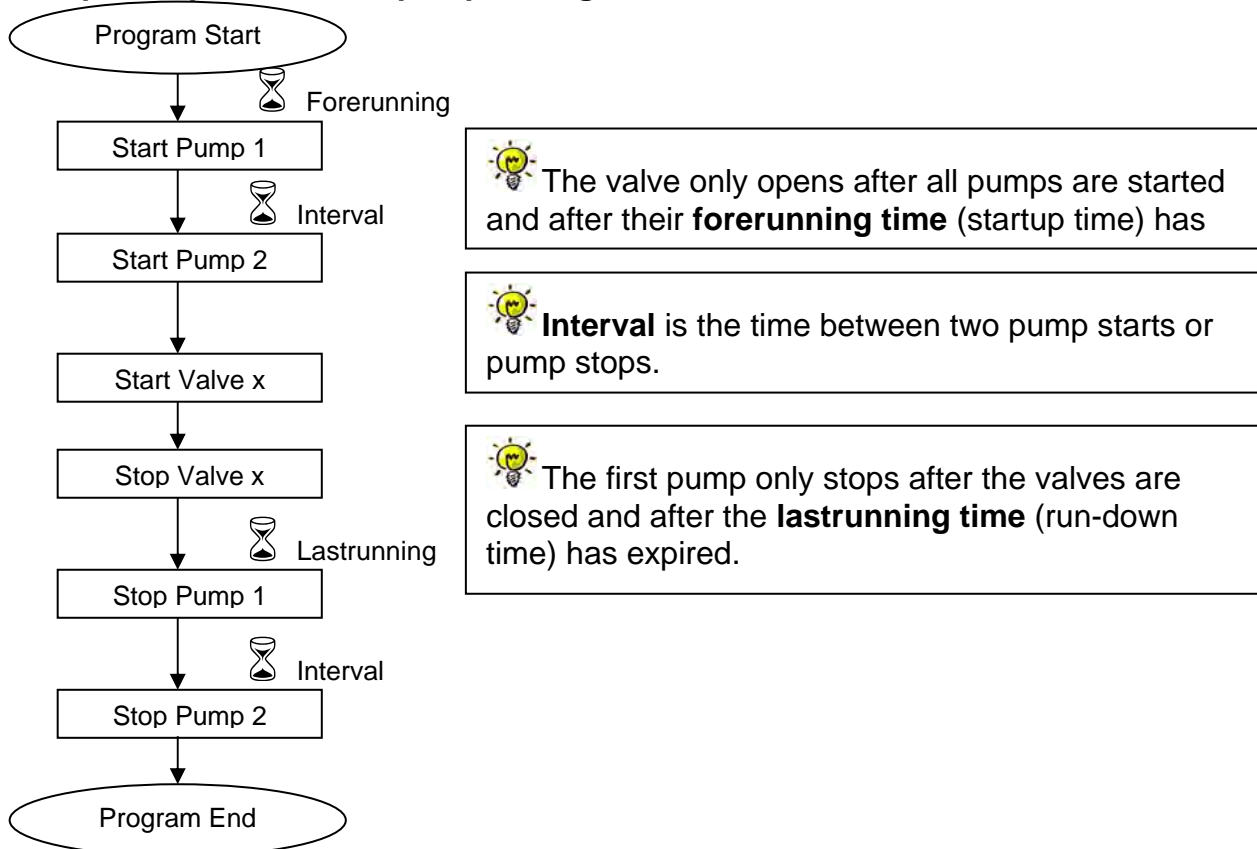

The interval, the forerunning and the last running are delay times suitable for the irrigation technique. Their values are rather specific for each system and must be set up in such a way as to eliminate pressure surges (water hammering effect).

Standard values:

Interval: 5 sec.	(small pump capacity)	⇒ short interval)
Forerunning: 20 sec.	(many valves or long piping)	⇒ long forerunning)
Last running: 20 sec.	(many valves or long piping)	⇒ long last running)

Enter the pump management values in the following way:

In the Setup menu:

1.	Setup	Options
	Hydraulics	Go to the Hydraulics > Options menu.

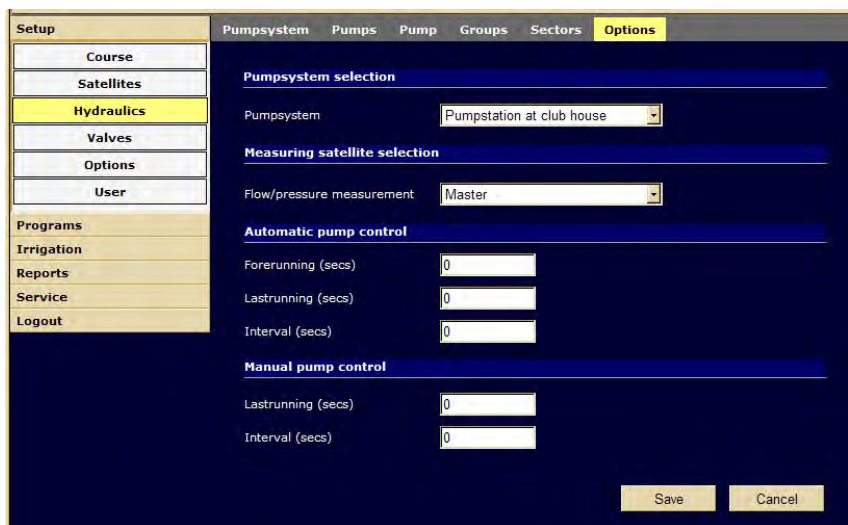

2.	Pump system	↓	Choose the required (previously saved) pump system in the Pumpsystem combo-box.
3.	Flow/pressure measurement		Are there flow/pressure measuring sensors installed in this pump system?
	Satellite	↓	Choose the required (previously saved) satellite to which the sensor is connected – from the combo-box.

Automatic pump control:

4.	Forerunning:		Click the Forerunning data field.
5.			Key in a forerunning (startup) time in seconds. You should monitor the pressure during irrigation to confirm that the entered values are correct.
6.	Lastrunning:		Click the Lastrunning data field.
7.			Key in a lastrunning (run-down) time in seconds. You should monitor the pressure during irrigation to confirm that the entered values are correct.

8.	Interval:	
----	-----------	---

Click the **Interval** data field.

9.		
----	---	--

Key in an interval time in seconds.



You should monitor the pressure during irrigation to confirm that the entered values are correct.

Manual pump control (manual opening of valves):

You can open valves manually from:

- ✓ the **Irrigation > Surveillance > Overview** menu (see chapter 8.4)
- ✓ the **Service > Satellite > Decoder** menu
- ✓ transmitter
- ✓ PDA

10.	Lastrunning:	
-----	--------------	---

Click the **Lastrunning** data field.

11.		
-----	---	--

Key in a lastrunning (run-down) time in seconds.



To shorten the waiting time, it is recommended to key in a shorter lastrunning time.

12.	Interval:	
-----	-----------	--

Click the **Interval** data field.

13.		
-----	---	--

Key in a interval time in seconds.



To shorten the waiting time, it is recommended to key in a shorter interval time.

14.	Save	
-----	------	---

Click the **Save** button.

5.9.2 Pump Control by Irrigation Programs

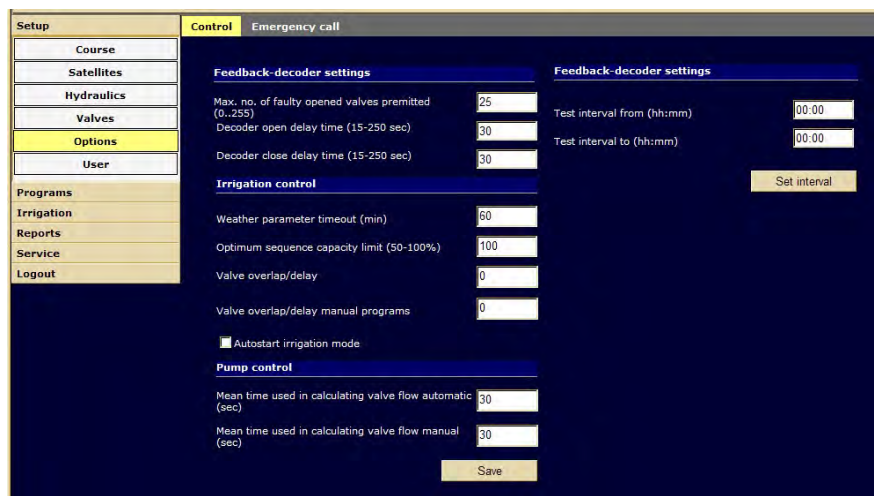

In the case that all the pumps are controlled through a decoder, the pump control in *Perrot Satellite* has been modified in such a way that activated pumps supply exactly the required quantities of water (flow).

Pump Management in Irrigation Programs

During irrigation, the required capacity of pumps is checked at intervals set under **Setup > Options > Control** (see chapter 5.7).

Based on such a check, the optimum pump combination is calculated.

This optimum combination is achieved through activating and deactivating different pumps. Activation has always priority to deactivation. Only one pump can be activated/deactivated during each interval.

Pump Management in Valve Opening/Closing through the Overview Menu, a Transmitter or a PDA

Pump activating and deactivating is done the same way as described earlier.

Mean time used in calculating valve flow manual (i.e. Update interval for pump capacity)

This field is important only if more pumps are controlled by a decoder simultaneously. In such a case, the pump control is taken over by *Perrot Satellite*. The program modifies the pump capacity according to the current demand.

The interval in which individual pumps will be activated/deactivated can be specified in this field.

The value entered in this field will apply to all irrigation programs.

Acceptable values: 0 – 9999 sec.

Standard value: 30 sec.



If you set the pump capacity update interval to "0" seconds, it turns the pump management off and all pumps will run simultaneously during the selected irrigation program.

Mean time used in calculating valve flow automatic (special function)

The optimum pump sequence is determined during the operation of an irrigation program, based on the currently calculated flow through different valves. This helps to reduce the effects of flow fluctuations during the irrigation process. The optimum pump sequence is always determined thanks to the built-in calculation of mean values.

This field serves for entering the interval stating how often the mean value should be calculated during the irrigation process. It depends on the current flow through valves. The valve flow in the last 30 seconds determines the calculation of the pump sequence and it is based on the 30 sec. mean value.

The value entered in this field sets the calculation interval.

Standard: 30 sec.

6 Irrigation Programs

The *Perrot Satellite* software makes it possible to create optimum irrigation programs. These irrigation programs are tested by their internal simulation.

The simulation then serves for calculating the optimum irrigation process by the integrated *Pump-Flow-Manager* with respect to the entered basic data.

Then the irrigation process is calculated in such a way as to use the available pump capacity most efficiently, not exceeding 100%. This will achieve the shortest possible irrigation time and the optimum use of the system resources (pumps, piping, etc.).

6.1 Description of Different Program Types

6.1.1 Valves (individual valves)

To create an irrigation program, you have to set an irrigation time or a precipitation density under the **Setup > Valves** menu. Valves to be activated by this particular program can be selected through the selection function.

This makes it possible to create individual programs for the widest range of irrigation needs for various areas located exposed to different conditions. Yet these values must be entered for each valve separately, which may become rather time consuming where there are large numbers of valves to be programmed.

Perrot Satellite then determines the irrigation procedure (valve activation order) by means of a simulation. The user can change the order of valve activation if needed.

6.1.2 Valve Collections

If you want to create programs using valve collections, you have to start by creating these collections and then specifying which particular valves you want to include in a particular collection.

It might be beneficial to include all valves irrigating greens or fairways in one collection.

This way, you can then set different precipitation densities for different valve collections and then modify these values to optimise the irrigation efficiency.

This method of valve collecting has the advantage of a low number of values to enter, which makes programming and data monitoring very easy and saves operator's time. Only the initial creation of collections is rather time consuming.

Perrot Satellite then determines the irrigation procedure (valve activation order) by means of a simulation. The user can change the order of valve activation if needed.

6.1.3 Manual Program

This type of program is not controlled by the *Flow-Manager* but rather by the operator who determines which valves should open together and in which order. The operator also determines, which pump(s) should be activated. The program then performs its tasks step-by-step where each step can have up to 8 valves assigned to it by the operator. Individual valves open shortly one after another within one step. The

operator can, however, program a delay between individual valve openings and closings.

This type of programming allow the operator to choose a completely arbitrary order of valve/pump activation and/or their combinations – something that is not possible in the other two program types, which have the order and combination of valves and pumps determined by the software *Flow-Manager*. As this type of programming is very time consuming, it is recommended to use it only for the above cases or situations.



Should there be changes made in the irrigation program settings or data which prolong or shorten the program running time, the *Perrot Satellite* software will process the new values automatically. The only thing you must check and make sure of is that the times of individual irrigation programs (if prolonged) do not overlap in the irrigation calendar.

6.2 Creating Irrigation programs

Main programming steps:

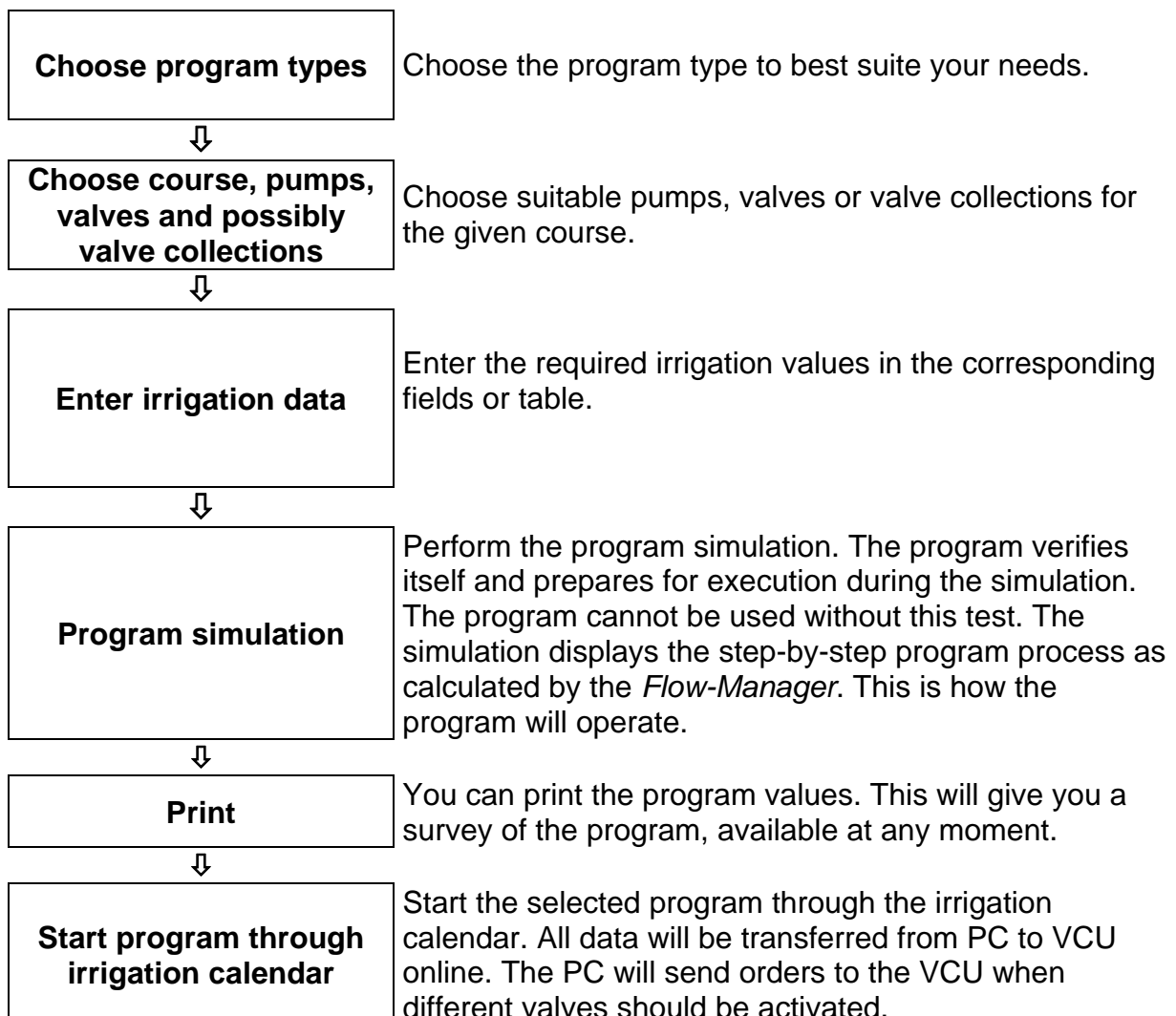

6.2.1 Programming Individual Valves

This is where all valves recorded in the programming table and marked as active can be opened. The software considers the pump data, entered precipitation density and program running time to achieve the optimum pump capacity.

The order, in which valves open, is determined by the software, or alternatively it can be defined manually in a special programming table column.

6.2.2 Programming Valve Collections

If you do not want to program each valve separately, you can combine selected valves in the given course into a valve collection.

The "*Valve Collection*" program type then opens all valves included in the particular collection, while respecting the pump values. The order in which valves open is determined by the *Flow-Manager*. This order does not depend on the collection assignment.



Advantage: This program type offers an easy to survey table. Even large numbers of valves can be controlled by means of one collection.

Disadvantage: This program type cannot control individual valves directly (unless one valve is defined as a whole collection).

6.2.3 Operator-Controlled Program Operation

Prepared for special types of programs only (see chapter 6.1.3).

6.3 "Valve" Irrigation Program



You need to have the *technician* rights to create new programs.

To create a new irrigation program, proceed as follows:

In the main menu:

1.	Programs	Edit
	Valves	Go to the <i>Valves</i> submenu.

The program table:

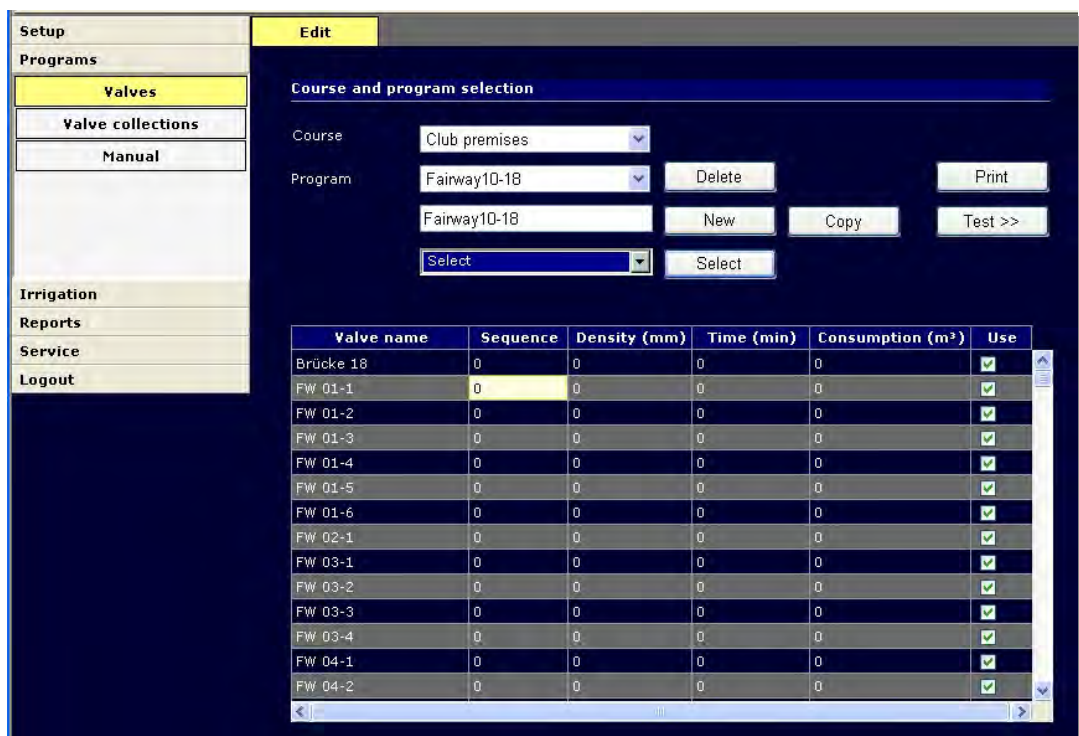

The screenshot shows the 'Edit' menu with options: Programs, Valves, Valve collections, Manual, Irrigation, Reports, Service, and Logout. The 'Valves' submenu is open, showing a table with columns: Valve name, Sequence, Density (mm), Time (min), Consumption (m³), and Use. The table contains 20 rows of valve data.

Valve name	Sequence	Density (mm)	Time (min)	Consumption (m³)	Use
Brücke 18	0	0	0	0	<input type="checkbox"/>
FW 01-1	0	0	0	0	<input checked="" type="checkbox"/>
FW 01-2	0	0	0	0	<input checked="" type="checkbox"/>
FW 01-3	0	0	0	0	<input checked="" type="checkbox"/>
FW 01-4	0	0	0	0	<input checked="" type="checkbox"/>
FW 01-5	0	0	0	0	<input checked="" type="checkbox"/>
FW 01-6	0	0	0	0	<input checked="" type="checkbox"/>
FW 02-1	0	0	0	0	<input checked="" type="checkbox"/>
FW 03-1	0	0	0	0	<input checked="" type="checkbox"/>
FW 03-2	0	0	0	0	<input checked="" type="checkbox"/>
FW 03-3	0	0	0	0	<input checked="" type="checkbox"/>
FW 03-4	0	0	0	0	<input checked="" type="checkbox"/>
FW 04-1	0	0	0	0	<input checked="" type="checkbox"/>
FW 04-2	0	0	0	0	<input checked="" type="checkbox"/>

Valve name.: This column displays names of all valves saved for this course. Each valve is displayed in a separate **row**.

Sequence: Enter the order of opening.
 Values: 0 – total No. of valves
 If the standard value of 0 is left in the field, the Flow-Manager sets the sequence **automatically**.
 You can change the order of opening by specifying sequential numbers from 1 to nn for individual valves (where nn is the total number of valves). The valves with the lowest sequence number opens as the first one and so on.



The sequence numbers must be filled-in for all valves!
All valves must have either 0 or 1-nn value specified.

Density: Enter the required precipitation density here.
 Values: **0 - 999 mm**

Based on your entered values and on the basic values, the Flow-Manager calculates how long the valve must be open and the water consumption in m³/h and write these values automatically in the corresponding fields.

Time: Enter the required duration the valve should be open: **0 - 479 minutes**
Once you enter your value, the precipitation density is calculated automatically.

Consumption: This field displays the calculated water consumption (m³/h).

Use Here you can activate or deactivate individual valves.
 = active = deactivated





Valves with the **time** or **consumption** value specified as 0 do not have to be deactivated as they are skipped in the irrigation program anyway.

2.	Course	↓	Select one of the saved courses – the one for which you want to create an irrigation program. Valves created for this course will display in the table.
----	--------	---	---

There are 2 methods to create a new irrigation program:

6.3.1 Creating a New Irrigation Program (from scratch)

Procedure:

1.	Programs:		Click the data-entering field. If the field already contains a name, highlight it completely with the mouse.
2.			Key in a new program name. Give your program a unique name up to 8 characters (letters or digits) long. Choose a name, which describes the purpose or use of the program.
3.	New		Click the New button. The system accepts the new program name and deletes (zeroes) all values in it.
4.	Valves / Edit		Open the pull-down menu of the Select combo-box by clicking it.
5.	Valves / Edit		Choose valves for which you want to create the new program.



Warning:

You can tick only **one** tickbox at a time. Confirm your selection by clicking the **Select** button. Then the pull-down menu can be reopened.



Note:

Valves without a (sorting) name will be displayed automatically.

6. Valves / Edit

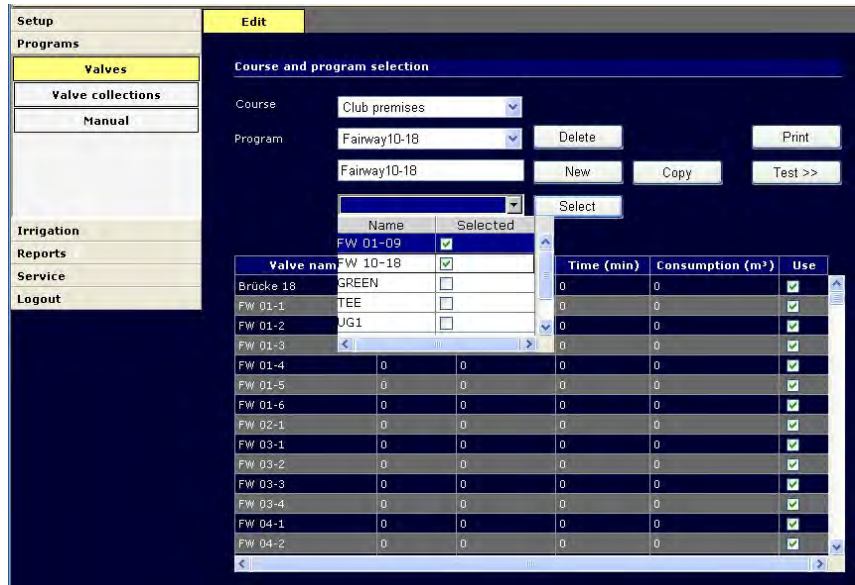

7. Valves / Edit

Additional valve collections can be added to an existing program or existing collections deleted from it. All valves are displayed in one list. Use the scrollbar in long lists.

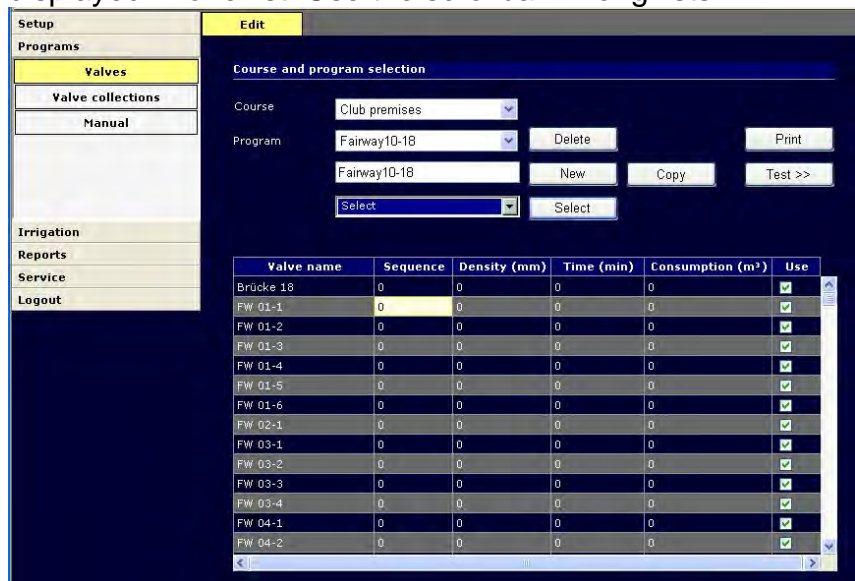

Modifying Table (Entering Values and Activating Valves)

2a.

Density column
Enter density

Click the field at the intersection of the **Density** column and the required valve row.

or

2b.

Time column
Enter time

Click the field at the intersection of the **Time** column and the required valve row.

3.	
----	---

Key in your value.

The density value is in [mm]
The time value is in [min]

Sequence column

4.	Enter sequence
----	----------------

Click the field at the intersection of the **Sequence** column and the required valve row.

5.	
----	---

Key in your value.

Make sure that all valve collections have either 0 or 1-nn as their value.

Entering the opening order (sequence)

Value: 0 – total No. of valves

If the standard value of 0 is left in the field, the Flow-Manager sets the sequence **automatically**.



You can change the order of opening by specifying sequential numbers from 1 to nn for individual valves (where nn is the total number of valves). The valve with the lowest sequence number opens first and so on.

The sequence numbers must be filled in for all the valves! Make sure that all the valves have either **0** or **1-nn** value specified.

6.	Test >>
----	---------

Click the **Test >>** button. This will start the simulation of your program.

The program cannot be executed without this simulation!

The program is verified for correctness by the test and prepared for running. It is not possible to start the program without this test.



The simulation test performs the program exactly according to the Flow-Manager's calculations.

The program will run the same way during real irrigation.







	Print
---	-------

Click the **Print** button. A print preview window opens displaying all the program data. You can print this report if there is a printer connected to your PC.

Valves program

Course name **Club premises**
 Program name **Fairway 10-18**
 Duration (hh:mm) **05:21**
 Consumption (m3) **177.28**

28/01/2009 13:52:01

Valve name	Sequence	Density (mm)	Time (hh:mm)	Consumption (m ³)	Used
Bridge 18	0	0	0	0	
FW 10-1	0	7	10	4.5	
FW 10-2	0	6	8	3.6	
FW 10-3	0	6	8	3.6	
FW 10-4	0	7	10	4.5	
FW 10-5	0	7	10	4.5	
FW 10-6	0	7	10	4.5	

6.3.2 Making a Copy of an Existing Program (Saving it under a Different Name)

Procedure:

1.	Program	↓
2.	Program:	
3.	Copy	
4.	Modify data	
5.	Test >>	

Select the program you want to copy in this combo-box. The table displays all the values saved for this program.

Key in a new program name.



Give your program a **unique name** up to 8 characters (letters or digits) long.

Click the **Copy** button. All the values are preserved in the table, but under the new name now.

Modify necessary values as described in the previous section (6.3.1 Creating a New Irrigation Program).

Click the **Test >>** button. This will start the simulation of your program.



The program cannot be executed without this test!

6.4 "Valve Collection" Irrigation Program

6.4.1 Creating Valve Collection Budgets

To create an irrigation program using a valve collection budget, proceed as follows: Create the required valve collection names in the **Setup > Course > Valve collections** menu,

for example: FW01 (for all sprinklers on Fairway 1)

or

G11 (for all sprinklers on Green 11)



Assign individual valves to valve collections in the **Setup > Course > Valve collection** menu:

- ✓ Choose one of the already created valve collection names.
- ✓ Choose the valves you want to include in the selected valve collection by clicking them in the left (white) field and by clicking the **Add >>** button.
- ✓ The **Budget %** field will show the percentage of the irrigation time assigned to this valve collection compared to the total irrigation time.

All the budget values can be modified at any time. The operator can gradually "tune the times in" to achieve the optimum results for all the valve collections and the irrigated areas. The modified values are automatically transferred into all the irrigation programs created in the **Programs > Valve collections > Edit** menu.

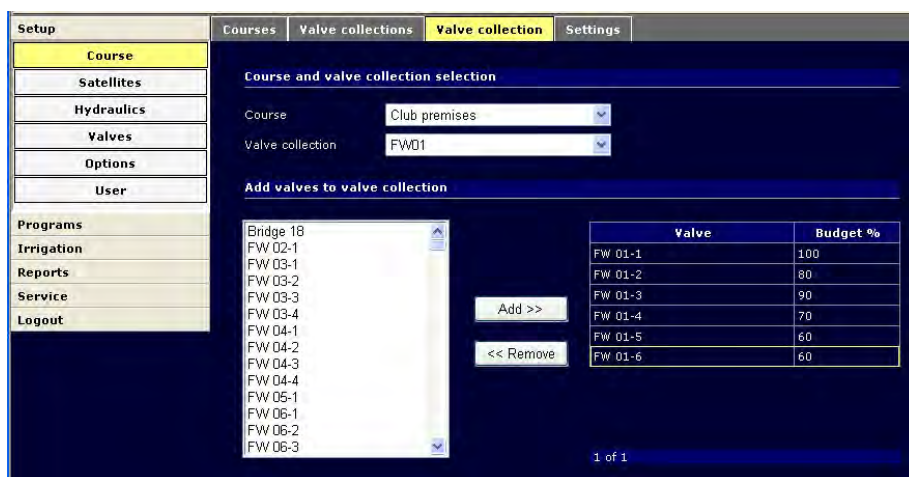

6.4.2 Creating a "Valve Collection" Irrigation Program



You need to have *technician* rights to create a new irrigation program.

To create a new irrigation program, proceed as follows:

In the main menu:

1.

1.	Programs	Edit
	Valve collections	Go to the Valve collections submenu.
2.

2.	Course	↓
----	--------	---

 Choose one of the previously saved courses for which you want to create an irrigation program. All valve collections created for the chosen course will display in the table.

The programming table:

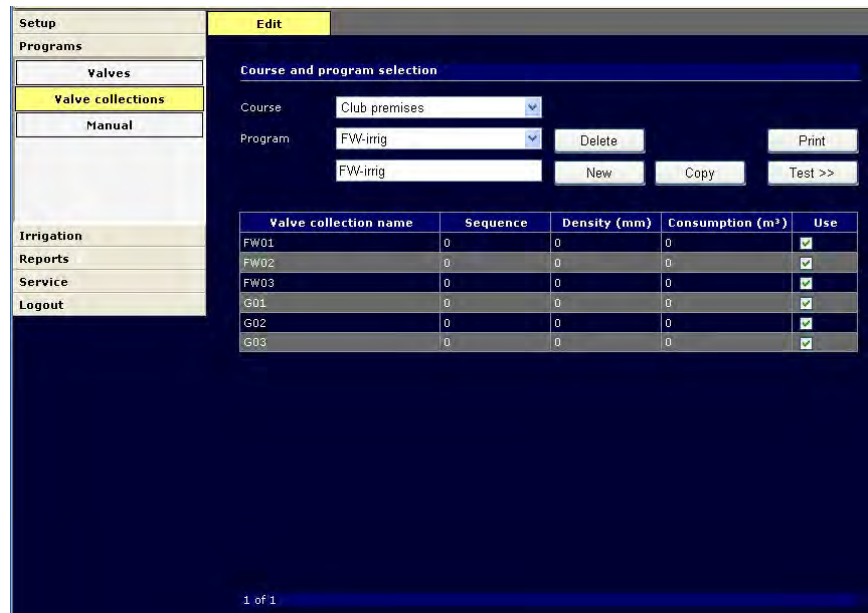

Valve collection name	Sequence	Density (mm)	Consumption (m³)	Use
FW01	0	0	0	<input checked="" type="checkbox"/>
FW02	0	0	0	<input checked="" type="checkbox"/>
FW03	0	0	0	<input checked="" type="checkbox"/>
G01	0	0	0	<input checked="" type="checkbox"/>
G02	0	0	0	<input checked="" type="checkbox"/>
G03	0	0	0	<input checked="" type="checkbox"/>

Valve collection name: Names of all valve collections created for this course.



These valve collections must be previously created and defined in the **Setup > Course > Valve collection** menu (see chapter 6.4.1).

Sequence:

To define the sequential order.

Values: 0 - max. number of valve collections

If the standard value of 0 is left in the field, the Flow-Manager sets the sequence **automatically**.

You can change the order of opening by specifying sequential numbers from 1 to nn for individual collections (where nn is the total number of valve collections). The collection with the lowest sequence number opens as the first one.



The sequence numbers must be filled-in for all valve collections!

All collections must have either 0 or 1-nn value specified.

Density:

Enter the required precipitation density here.

Values: **0 - 999 mm**

Based on your entered values and on the basic values, the Flow-Manager calculates how long the valves must be open and the water consumption in m³/h and write these values automatically in the corresponding fields.

Consumption:

This field displays the calculated water consumption (m³/h).

Use





Here you can activate or deactivate individual valves.

= active = deactivated





There are 2 methods to create a new irrigation program:

6.4.3 Creating a New Irrigation Program (from scratch)

Procedure:

1.	Programs:		Click the data-entering field. If the field already contains a name, highlight it completely with the mouse.
2.			Key in a new program name.  Give your program a unique name up to 8 characters (letters or digits) long. Choose a name, which describes the purpose or use of the program.
3.	New		Click the New button. The system accepts the new program name and deletes (zeroes) all values in it.
4.	Valves / Edit		Open the pull-down menu of the Select combo-box by clicking it.
5.	Valves / Edit		Choose valves for which you want to create the new program.

Modifying Table (Entering Values and Activating Valves)

	Density column		
1.	Enter density		Click the field at the intersection of the Density column and the required valve row.
2.			Key in your value. The density value is in [mm] (Time cannot be entered for valve collections.)
	Sequence column		
3.	Enter sequence		Click the field at the intersection of the Sequence column and the required valve row.
4.			Key in your value.  Make sure that all the valves have either 0 or 1-nn value specified. If a sequence number higher than 0 is specified, the valves in the collection with the lowest sequence number open as the first ones.
5.	Test >>		Click the Test >> button. This will start the simulation of your program.  The program cannot be executed without this simulation!
	Print		Click the Print button. A print preview window opens displaying all the program data. You can print this report if there is a printer connected to your PC.

Valve collection program

Course name **Club premises**
 Program name **FW-irrig**
 Duration (hh:mm) **00:00**
 Consumption (m3) **0**

28/01/2009 14:09:30

Valve Collection	Sequence	Density (mm)	Consumption (m ³)	Used
FW01	0	0	0	True
FW02	0	0	0	True
FW03	0	0	0	True
G01	0	0	0	True
G02	0	0	0	True
G03	0	0	0	True

6.4.4 Making a Copy of an Existing Program (Saving it under a Different Name)

Procedure:

1.	Programs	
----	----------	--

Select the program you want to copy in this combo-box. The table displays all the values saved for this program.

2.	Program:	
----	----------	--

Key in a new program name.



Give your program a **unique name** up to 8 characters (letters or digits) long.

3.	Copy
----	------

Click the **Copy** button. All the values are preserved in the table, but under the new name now.

4.	Modify data
----	-------------

Modify necessary values as described in the previous section (6.3.1 Creating a New Irrigation Program).

5.	Test >>
----	---------

Click the **Test >>** button. This will start the simulation of your program.



The program cannot be executed without this test!

6.5 "Manual" Irrigation Program

6.5.1 Procedure

Main programming steps:

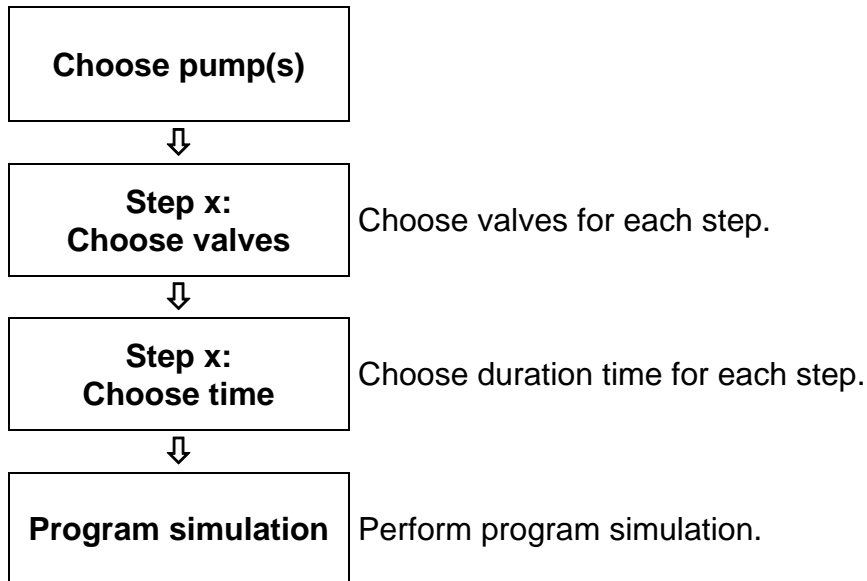

**Warning! The pump capacity must not be exceeded!
Incorrect data might result in overloading the pumps!**



These "manual" programs should be programmed by sufficiently experienced experts only.



It is recommended to record the planned program step-by-step on a sheet of paper. Only after you check all its steps and compare them with the pump capacity can you start entering its individual steps in the software.



You need to have *technician* rights to create new programs.

To create a new irrigation program, proceed as follows:

In the main menu:

1.	Programs	Edit
----	----------	------

Manual	Go to the Programs > Manual submenu.
--------	--

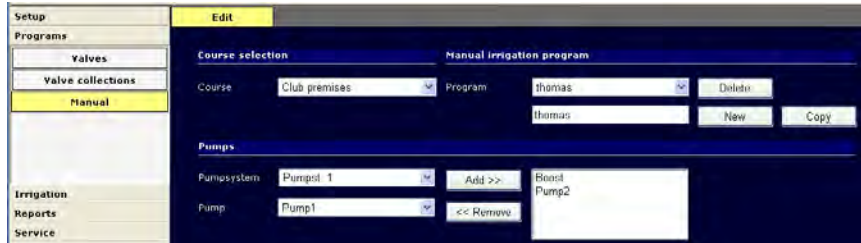

2.	Course	↓
----	--------	---

Select one of the saved courses – the one for which you want to create an irrigation program.

There are 2 methods to create a new irrigation program:

6.5.2 Creating a New Irrigation Program (from scratch)

Procedure:

1.	Programs:	
----	-----------	--

Click the data-entering field. If the field already contains a name, highlight it completely with the mouse.

2.	
----	--

Key in a new program name.



Give your program a **unique name** up to 8 characters (letters or digits) long. Choose a name, which describes the purpose or use of the program.

3.	New
----	-----

Click the **New** button. The system accepts the new program name and deletes (zeroes) all values in it.

Select pump(s)
Enter the step No.
Choose valve(s)
Enter running time

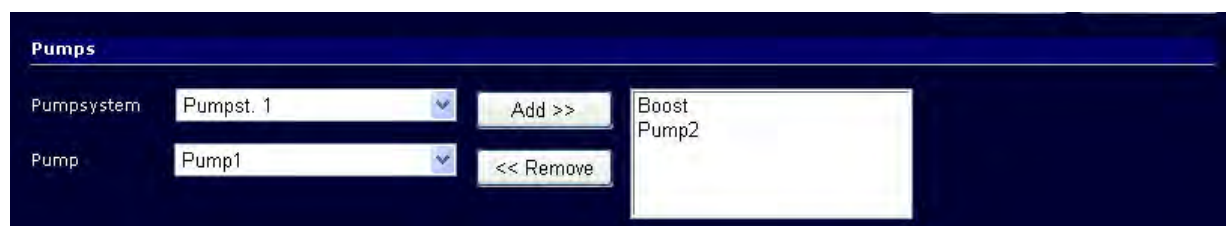

4.	Pumpsystem	↓
----	------------	---

Choose the required pump system to which the activated pump is connected.

5.	Pump	↓
----	------	---

Choose the pump to activate.

6.	Add >>	
----	--------	--

Click the **Add >>** button.

7.	Additional pumps?	Pump	↓
		Add >>	

You can add additional pumps to the right-side list-box by choosing another pump and transferring it to the box by clicking the **Add >>** button.

Removing Pumps from List-Box

Choose pump

Choose the required pump in the list-box.

<< Remove

Remove the highlighted pump from the list-box by clicking the << **Remove** button.



This, however, changes the overall pump capacity. Check the available pump capacity listed on the screen for each step.



The chosen pumps apply to the whole program. They cannot be changed for individual steps.

Select pump(s)

Enter the step No.

Choose valve(s)

Enter running time

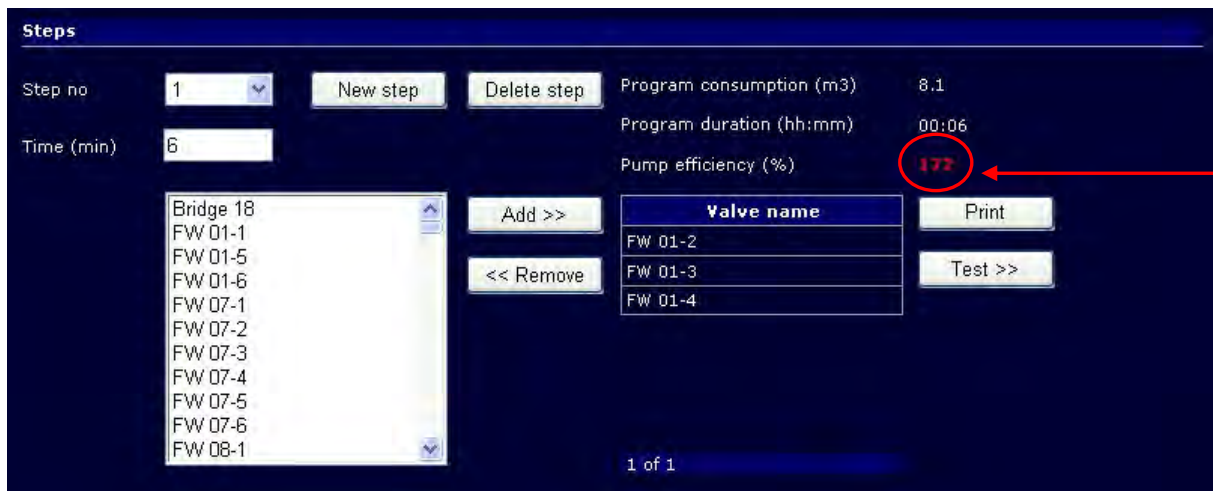

8. **New step** As a new program is being compiled, the **Step No.** field will be filled with "0". Clicking the **New step** button will insert the next (higher) number in the **Step No.** field.



New step			Delete step		
Step no.	↓	Choose step No.	Step No.	↓	Choose step No.
New step		This creates a new step. The new step will be numbered as the current step +1 .	Delete step		This deletes the current step. The next step will be numbered as the current step -1 .

Enter the step No.

Choose valve(s)



Enter running time





9. Valve list ↓

Choose the required valve in the left-hand list-box.

10.	Add >>	Click the Add >> button. The valve will be displayed in the Valve name table in the right.	
11.	Additional valves?	Valve list	 You can add additional valves to the right-side list-box by choosing another valve and transferring it to the box by clicking the Add >> button.
		Add >>	

**Enter the step No.
Choose valve(s)
Enter running time**

12.	Time (min)		Click the Time (min) data field.
13.			Key in the required running time (length) for the displayed step.

	Pay attention to the information that appears on the screen for the displayed step!	
	Program consumption(m³)	This displays the water consumption for the current step.
	Program duration (hh:min)	This displays the running time (duration) of the valves chosen for the current step.
	Pump efficiency (%)	This displays the needed pump capacity for the valves chosen for the current step.
	Warning! You must check the available pump capacity in this type of program! Incorrect data might exceed the pump capacity resulting in the pump overloading! (The pump capacity must not exceed 100%!)	

Individual steps are to be compiled as follows:

- | | | |
|---|--------------------|------------------------|
| 1 | Enter new step No. | See point No. 8 |
| 2 | Choose valve(s) | See point Nos. 9 - 11 |
| 3 | Enter running time | See point Nos. 12 - 13 |

14.	Test >>	Click the Test >> button. This will start the simulation of your program.
		 The program cannot be executed without this test!

Calculated manual program

Course Club premises Duration (hh:mm) 00:06
 Program thomas Consumption (m3) 8.1

Valve name	Start (hh:mm)	Stop (hh:mm)	Pump eff. (%)	Pump capacity (m ³ /h)	Pump flow (m ³ /h)
FW 01-2	00:00	00:06	172	47	81
FW 01-3	00:00	00:06	172	47	81
FW 01-4	00:00	00:06	172	47	81

Print << Edit

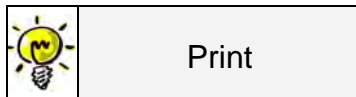

Click the **Print** button. A print preview window opens displaying all the program data. You can print this report if there is a printer connected to your PC.

Calculated manual program

Course name **Club premises**
 Program name **thomas**
 Duration (hh:mm) **00:06**
 Consumption (m3) **8.1**

28/01/2009 14:22:16

Valve name	Start (hh:mm)	Stop (hh:mm)	Pump eff. (%)	Pump capacity (m ³ /h)	Pump flow (m ³ /h)
FW 01-2	00:00	00:06	172	47	81
FW 01-3	00:00	00:06	172	47	81
FW 01-4	00:00	00:06	172	47	81

6.5.3 Making a Copy of an Existing Program (Saving it under a Different Name)

Procedure:

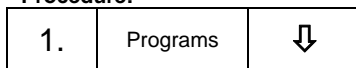

Select the program you want to copy in this combo-box. The table displays all the values saved for this program.

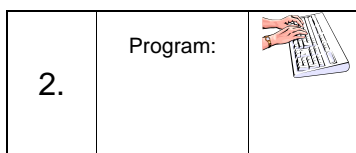

Key in a new program name.



Give your program a **unique name** up to 8 characters (letters or digits) long.



Click the **Copy** button. All the values are preserved in the table, but under the new name now.

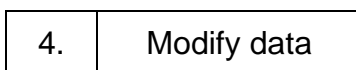

Modify necessary values as described in the previous section (6.3.1 Creating a New Irrigation Program).

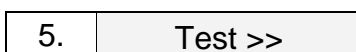

Click the **Test >>** button. This will start the simulation of your program.



The program cannot be executed without this test!

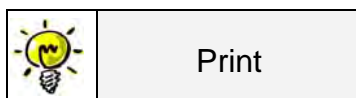

Click the **Print** button. A print preview window opens displaying all the program data. You can print this report if there is a printer connected to your PC.

6.6 Creating Irrigation Schedule



This schedule provides the overall control of the irrigation procedure. You can program it to specify which irrigation program should start automatically on which day of which week at which course and at what time.

The automatic irrigation control (schedule) can be programmed up to two weeks in advance. The schedule then repeats automatically.

You can start an unlimited number of programs each day.

To create a new schedule, proceed as follows:

In the main menu:

1.	Irrigation	Edit
	Schedule	Go to the Irrigation > Schedule > Edit menu.

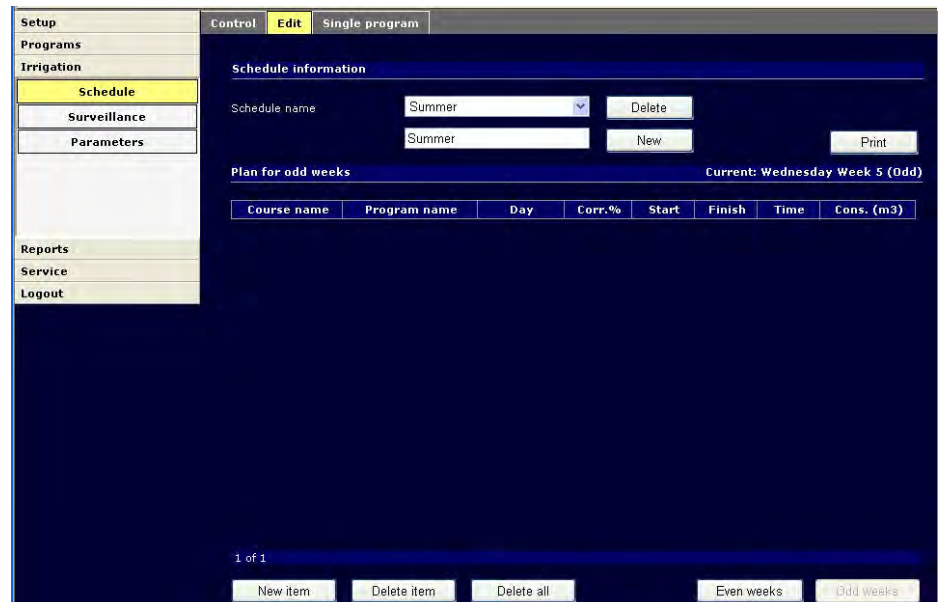

2.	Schedule name	
----	---------------	---

Click the **Schedule name** data field.

3.		
----	---	--

Key in a suitable name and save it by clicking the **New** button.





Choose a **unique** name, which describes the purpose or use of the schedule.

4.	Berechnungsplan	
----	-----------------	---

Click the **New item** button.

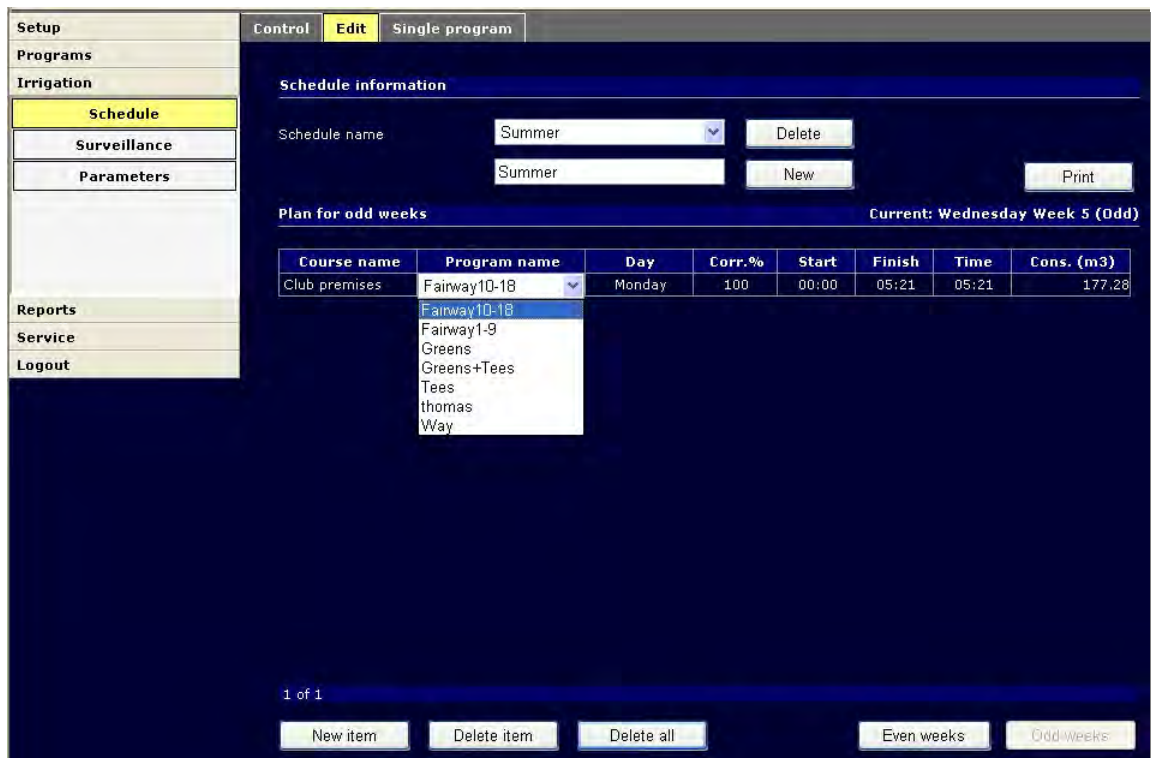
The system offers irrigation programs to choose from.



5.	Schedule	
----	----------	---

You can click individual fields in the table (Course name, Program name, Day, Corr.% or Start) and modify their values so that the selected program starts on the required day and at the required time.

6.	Schedule	
----	----------	---

To call up additional programs, click the **New item** button again and modify the values as described in the previous step.



There must be a pause of at least one minute between finishing a program and starting another.

Should program times overlap, the line will change its colour into **red**. You can remove such an overlap by changing the program start time. Schedules that contain overlaps **will not** be executed!



Irrigation programs can run simultaneously at different courses.



Changes made in start times of irrigation programs may prolong the overall time of the schedule and it may start overlapping with another schedule!



You can create an unlimited number of schedules with different irrigation frequency and/or intensity to suit different climatic and weather conditions (summer, autumn, sunny, cloudy).

Description of editable data fields:

Schedule name	This is where you can create new schedules. It is recommended to use meaningful names that describe their purposes, such as "Spring" or "Summer", for example.
Course name	If the irrigated area consists of several courses, choose the course in which you want to start the irrigation program.
Program name	The combo-box displays all tested programs assigned to this course.
Day	The combo-box displays all days of the week to choose from.
Corr.%	Here you can prolong or shorten the running time by a percentage (time with valves opened). Standard: 100%, min 10%, max. 300%.
Start	Here you can enter the required start time. The time is to be entered it in the hh:mm format.

Description of non-editable (display-only) data fields

Current	This field displays the current day of the week and information whether the current week is even or odd .
Plan for	This field displays information whether the currently displayed week is even or odd.
Finish	This field displays time at which the irrigation program will finish.
Time	This field displays the program running time (duration), taking into account the Corr.% factor for the given program.
Cons.	This field displays the calculated water consumption of the given program, taking into account its Corr.% factor.

Description of buttons

New	This button saves new schedules.
Delete	This button deletes both the schedule name and its content.
Print	This button opens the print preview of the given schedule.
New item	This button adds a new program in the current schedule.
Delete item	This button deletes the selected program from the current schedule.
Delete all	This button deletes all programs from the current schedule. The schedule is not deleted and can be redefined (= filled with programs).
Even/Odd weeks	The screen always displays only one week. These buttons toggle between even and odd weeks.

6.7 Automatic Irrigation Procedure

You can set your irrigation to run automatically in the *Irrigation > Schedule > Control* menu.

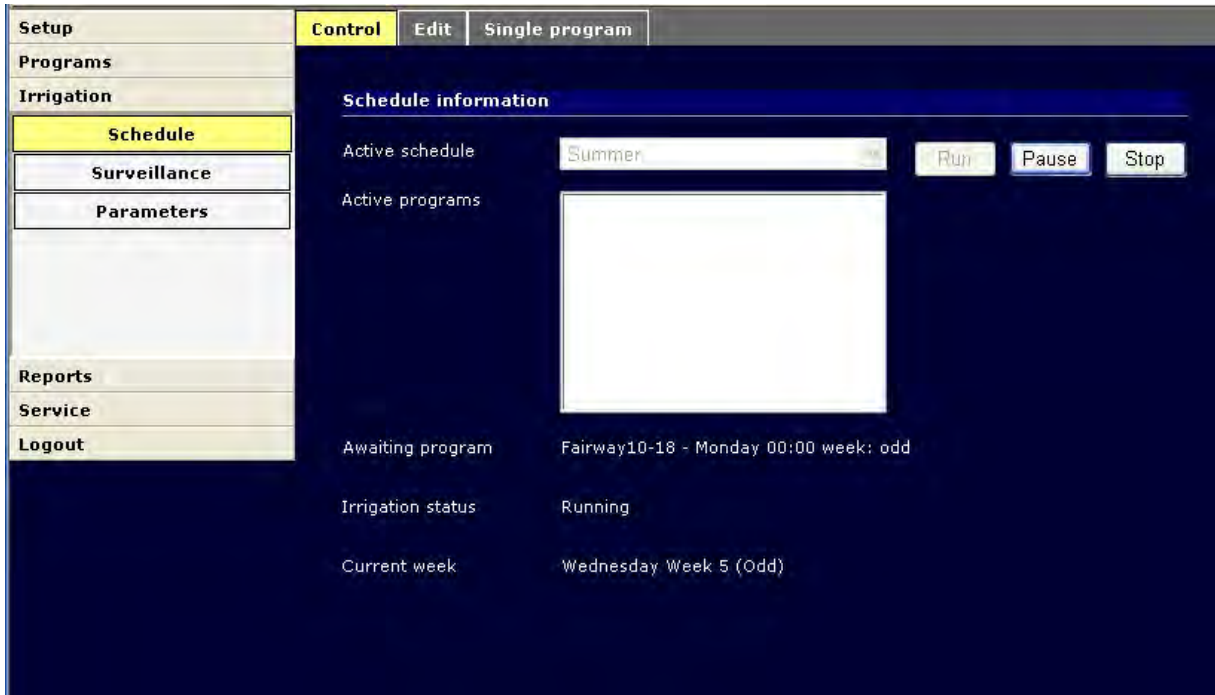

Procedure:

1.	Active schedule	↓	Choose the required schedule from the pull-down menu which displays all available schedules.
2.	Run		<p>Clicking the Run button activates the following steps:</p> <ul style="list-style-type: none"> ✓ The Awaiting program field displays the program which will start as the next one. It is always the program with the nearest start time. ✓ The Irrigation status changes from "Stopped" to "Running". <p>Once a schedule is started, it displays its programs in the Active programs list box.</p>
3.	Pause		<p>Clicking the Pause button interrupts the running program.</p> <ul style="list-style-type: none"> ✓ The Irrigation status changes from "Running" to "Paused". ✓ Clicking the Restart button resumes the program operation from the point at which it was paused.
4.	Stop		<p>Clicking the Stop button:</p> <ul style="list-style-type: none"> ✓ The Irrigation status changes from "Running" to "Stopped". ✓ The irrigation process stops, no further programs will be executed.

6.8 Irrigation Status – Terminology Explanation

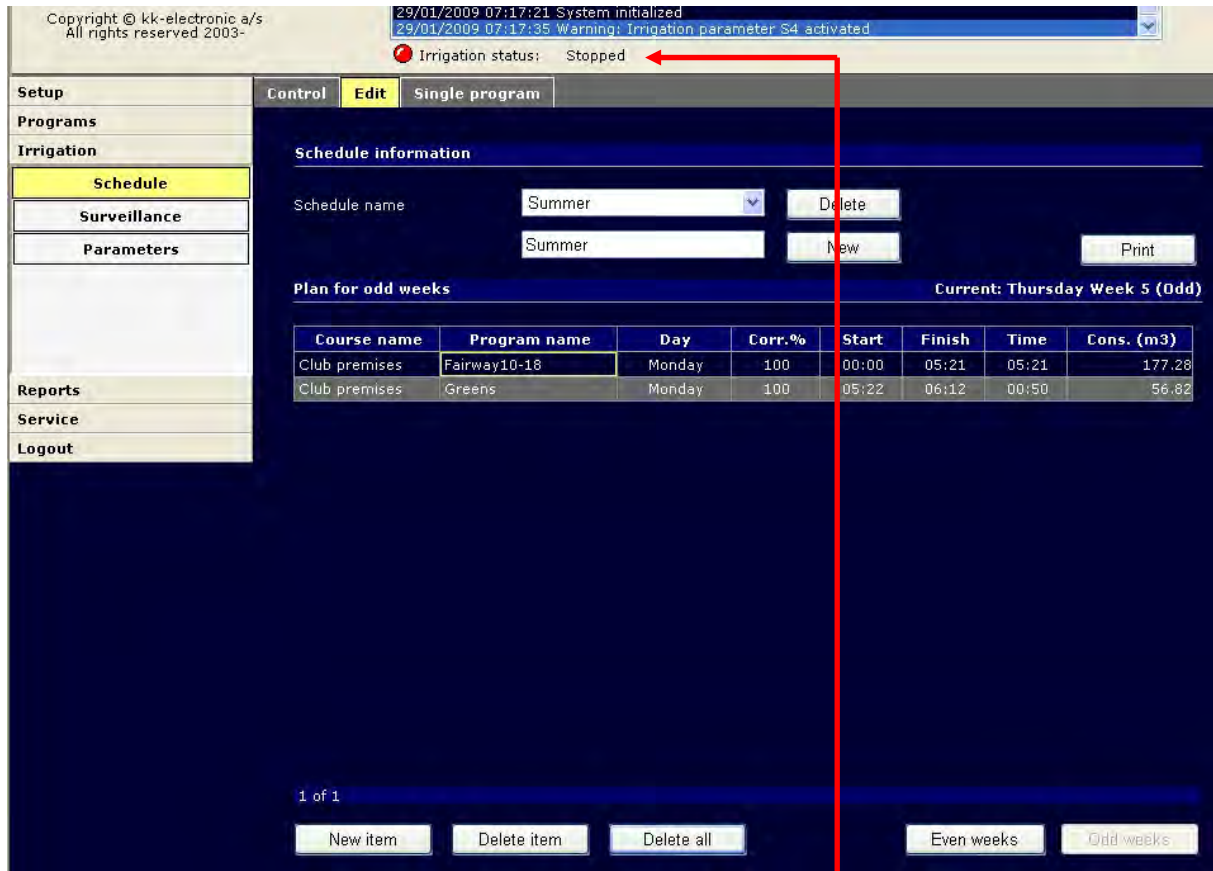

The **Irrigation status** line is always displayed on the screen regardless of the currently displayed menu. This way the user can check the current irrigation status at any moment.

The yellow LED on the VCU is another indicator of the irrigation status.

Following Table presents each possible status:

Irrigation status	Yellow LED on VCU	Situation	Note
Stopped	short on, long off blinking	No irrigation program will be automatically started.	Off mode
Running	long on, short off blinking	Irrigation programs will start automatically. The program will wait for the next start time.	Stand-by mode
Running	on	An irrigation program is running.	Running mode
Paused	long on, short off blinking	A running program has been paused (interrupted).	Stand-by mode Program execution can be resumed by clicking the Restart button
Weather	long on, short off blinking	During the "Running" irrigation status, one of the activated sensors had its limit value exceeded (specified under the Irrigation > Parameters menu. Irrigation cannot be started nor can a running program paused in this state.	Standby mode Irrigation can only resume after resetting the external sensor (automatically or by the user).
Error	off (the red LED is on)	The software has detected an error, which is described under the Service > Error handling menu.	Irrigation can only resume after removing the error and resetting the program.

6.9 Manual Start of Irrigation Program

You can manually start any irrigation program manually, regardless of the current time.

Remember the following points:



- ✓ Manual start can only be done in the "Stopped" irrigation status.
- ✓ The irrigation program changes its status into "Running" after the manual start.
- ✓ After the program execution, the irrigation status turns back to "Stopped".
- ✓ If a program is started manually, it cannot switch into automatic control mode and vice versa.

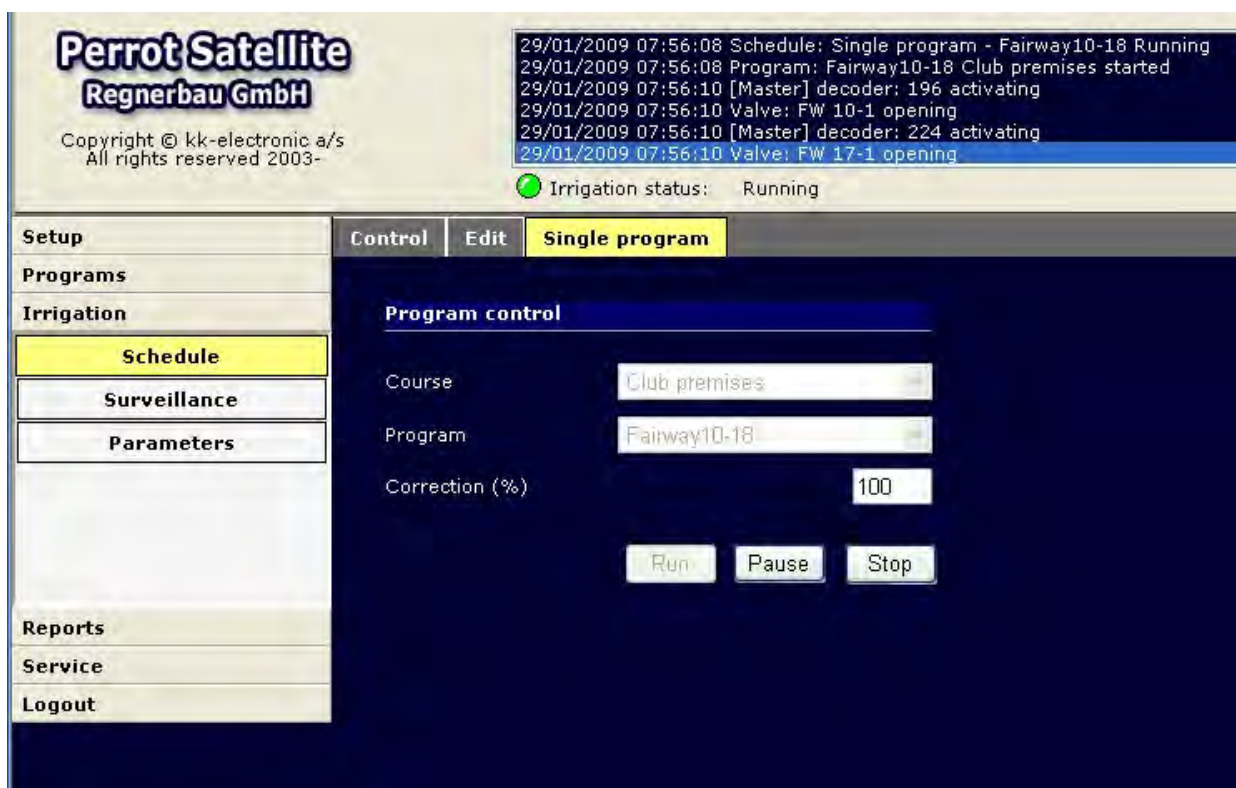

1.	Course	↓	Click the Course combo-box and choose the course for which you want manually start an irrigation program.
2.	Program	↓	Click the Program combo-box and choose the required program.
3.	Correction (%)		Change the correcting factor if needed.
4.	Run		Click the Run button.
5.	Program		The irrigation program starts immediately.

Start time and finish time of the manually started program display under the **Irrigation > Schedule > Control** menu and under the **Irrigation > Schedule > Edit** menu:

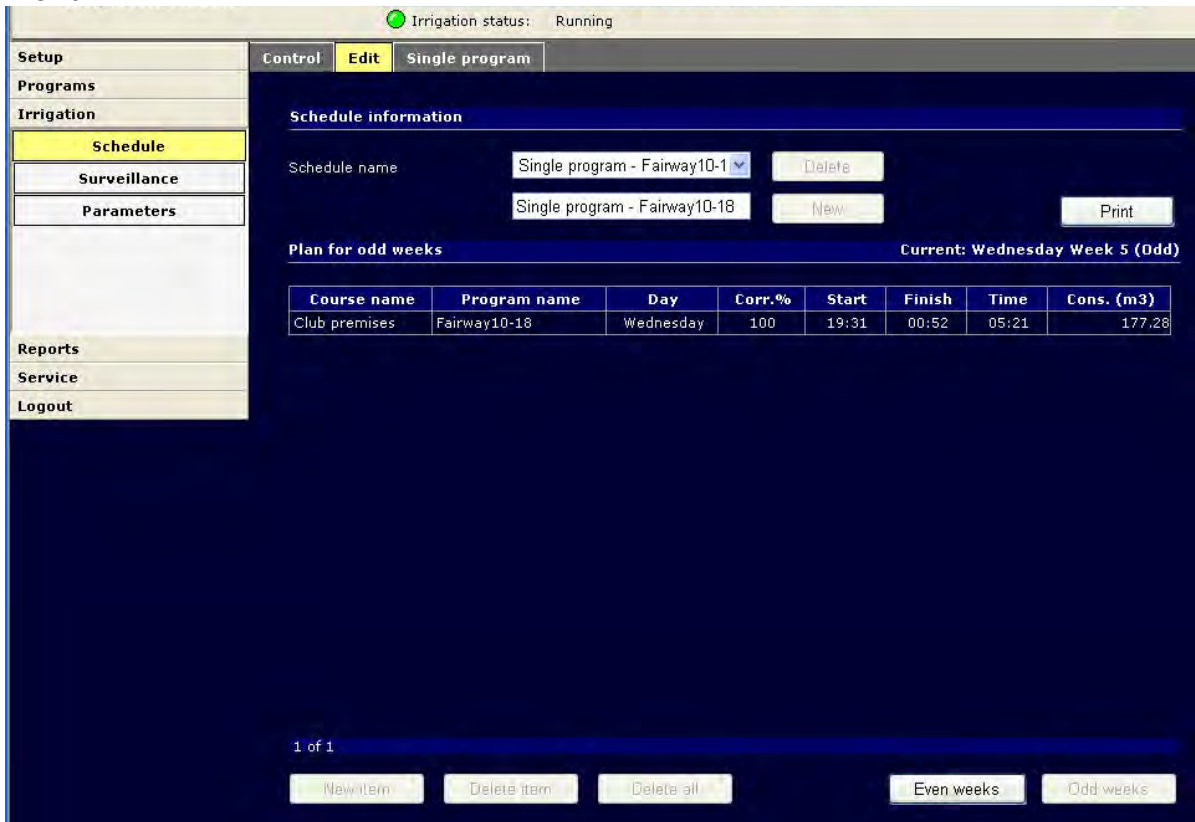

Irrigation status: Running

Control Edit Single program

Schedule information

Schedule name: Single program - Fairway10-1 [Delete]

Single program - Fairway10-18 [New] [Print]

Plan for odd weeks Current: Wednesday Week 5 (Odd)

Course name	Program name	Day	Corr.%	Start	Finish	Time	Cons. (m3)
Club premises	Fairway10-18	Wednesday	100	19:31	00:52	05:21	177.28

1 of 1

[New item] [Delete item] [Delete all] [Even weeks] [Odd weeks]

The **Active schedule** combo-box gives information that the irrigation program has been started manually (“Single program” displayed).

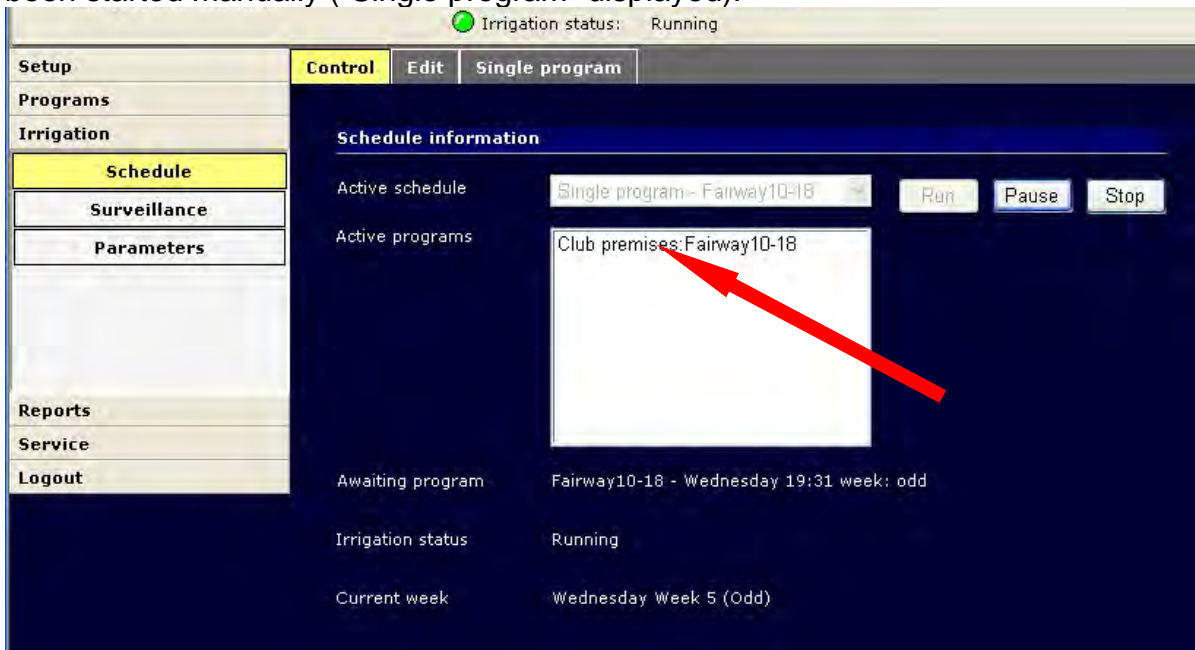

Irrigation status: Running

Control Edit Single program

Schedule information

Active schedule: Single program - Fairway10-18 [Run] [Pause] [Stop]

Active programs: Club premises: Fairway10-18

Awaiting program: Fairway10-18 - Wednesday 19:31 week: odd

Irrigation status: Running

Current week: Wednesday Week 5 (Odd)

7 Sensors and Other External Devices

You can affect the irrigation process in *Perrot Satellite* by means of various external devices such as rain sensors, flow/pressure sensors or wind sensors.

7.1 System Data and External Devices

Configuration menu for external devices:



	(Application)	(Scale)	(Offset)
S3 Closer		N/A	N/A
S4 Opener		N/A	N/A
S5 Q/I	Flow	0.0	0.0
S6 P/I	Pressure	0.0	0.0
S7 V/I	Wind speed	0.0	0.0
S8 XY/I		0.0	0.0
S9 Frequency 1		0.0	0.0
S10 Frequency 2		0.0	0.0

- S3 Closer:** This input is used for a rain sensor (digital input)
- S4 Opener:** This input is used for a rain sensor (digital input)
- S5 Q/I:** This input is used for a flow sensor (analog input, range 0-20 mA)
- S6 P/I:** This input is used for a pressure sensor (analog input, range 0-20 mA)
- S7 V/I:** This input is used for a wind gauge (anemometer) (analog input, range 0-20 mA)
- S8 XY/I:** This input can be used for another sensor (analog input, range 0-20 mA)
- S9 Frequency 1:** This input can be used for a sensor with a frequency output (frequency range must be greater than 5-10 Hz; input range: 0-1000 Hz)
- S10 Frequency 2:** This input can be used for a sensor with a frequency output (frequency range must be greater than 5-10 Hz; input range: 0-1000 Hz)
- Application:** Key in a suitable name for your external device in these fields, (e.g. what will be metered). The name can be up to 8 characters long.

Working with an External Sensor



Current (mA) values from the connected sensors are metered at VCU's inputs S5 to S8 and the readings sent to the software. Inputs S9 and S10 meter frequencies and also send the values to the software. The software recalculates these values into pressure or speed by means of the Scale and Offset parameters and prints the final values in a report or displays them on the screen of the *Irrigation > Parameters* menu.

7.1.1 Scale

As satellites (VCUs) can read values only in mA or Hz, the scale recalculates the readings to be presented as pressure/speed values.

Calculation: $1 \text{ Hz} = ? \text{ m/s}$ $\text{scale value} \times \text{metered value in Hz} = \text{displayed value in m/s}$
 $1 \text{ mA} = ? \text{ bar}$ $\text{scale value} \times \text{metered value in mA} = \text{displayed value in bar}$
 $1 \text{ mA} = ? \text{ m/s}$ $\text{scale value} \times \text{metered value in mA} = \text{displayed value in m/s}$

Example 1: Wind gauge sends 4.4 pulses per second (4.4Hz) in one revolution
 One revolution corresponds with a wind speed of 1 m/s.
 ? m/s = 1Hz: $\Rightarrow 1 \text{ m/s} : 4.4 \text{ Hz} = 0.22 \text{ m/s per 1 Hz}$ $\Rightarrow \text{Scale} = \mathbf{0.22}$

Example 2: Pressure sensor sends a linear signal of 4-20 mA corresponding with the pressure of 0-25 bar.
 ? bar = 1mA: $\Rightarrow 25 \text{ bar} : (20-4) \text{ mA} = 1.56 \text{ bar per 1mA}$ $\Rightarrow \text{Scale} = \mathbf{1.56}$



The sensor sends a value of 4 mA at the pressure of 0 bar, this means that the software would show $4 \times 1.56 \text{ bar} = 6.24 \text{ bar}$. For this reason the displayed value must be set off by means of the Offset parameter.

7.1.2 Offset

Offset is a correcting value applied to the Scale value of analog or frequency inputs. This correcting value is added to or subtracted from the measured and Scale-recalculated value. This means that the calculation of the value to be displayed uses the Scale value corrected by the offset value.

Range: -999.9 – +999.9

Example: Pressure sensor sends a linear signal of 4-20 mA corresponding with the pressure of 0-25 bar. Scale = 1.56 (see example 2 above).

Calculation: $\Rightarrow 4 \text{ mA} \times 1.56 \text{ bar/mA} = 6.24 \text{ bar}$ (displayed value)

Offset value: displayed value – Offset value = 0 bar \Rightarrow Offset value = **-6.24**



The scale-recalculated metered value is corrected by the offset value (with the minus sign). This results in the true displayed value.

7.2 Connecting a Rain Sensor

The rain sensor operates as a switch that closes in case of rain. It is directly connected to a satellite (VCU). If the rain sensor reports rain, *Perrot Satellite* pauses the irrigation process. Once the rain stops and the rain sensor pre-set delay expires, the irrigation program resumes its operation from the point at which it was paused.



Please follow producer's installation and operation instructions for your rain sensor. Do not activate any devices that have not been installed!



Do not install your rain sensor inside the irrigated area!



A rain sensor DOES NOT affect manually opened valves or manually started programs!

Depending on its type, a rain sensor can be connected to the VCU's digital input as a closer or an opener.

To connect a rain sensor as a **closer**, use
To connect a rain sensor as an **opener**, use

Terminals 11 and 12
Terminals 13 and 14

Wiring diagram

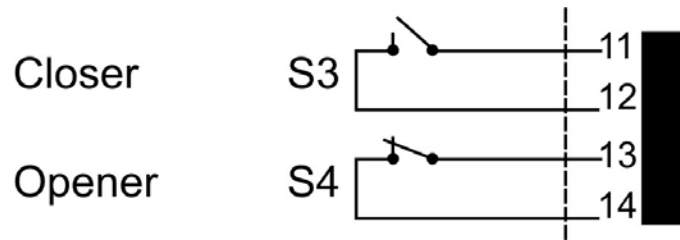

For an overall VCU wiring diagram see chapter 2.4.



Please make sure that a *Weather parameter timeout* has been defined in the **Setup > Options > Control** menu.



If the rain sensor does not open within the defined time, the currently running irrigation program pauses.

Should the resumed irrigation program overlap with another planned program, the paused (interrupted) program will be terminated.

Acceptable values: 0 – 999 min

Standard value: 60 min



Recommended rain sensor set:

Manufacturer: Hunter Mini-Click rain sensor

To register a rain sensor, proceed as follows:

In the main menu:

1.	Setup	Settings
	Satellites	Go to the Setup > Satellites > Settings menu.





2.	Satellite	↓	Choose one of the existing satellites.
-----------	-----------	---	--



Check which type of the rain sensor you have installed (opener or closer).

3.	Opener or closer		Click the Closer or Opener data field.
-----------	------------------	---	--



4.			Key in a suitable name. Use a unique name. The name can be up to 8 characters long (letters or digits).
-----------	---	---	--

5.	Save	Click the Save button.
-----------	-------------	-------------------------------

Once you have your rain sensor installed and all its installation values entered, you have to **activate** it. Only then it will be able to pause irrigation as needed.

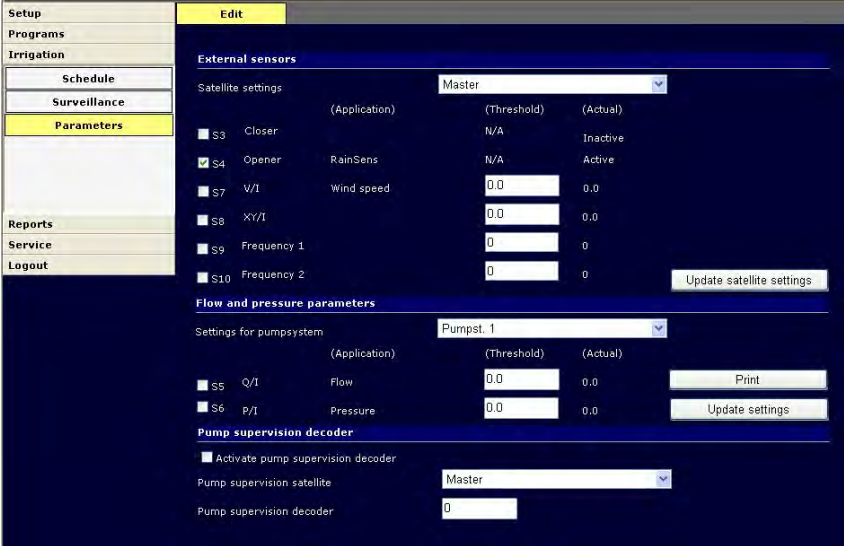
To activate a rain sensor, proceed as follows:

1.	Irrigation	Edit
	Parameters	

- | | | | |
|----|------------------|---|---|
| 2. | Satellite | ↓ | Choose the satellite to which your rain sensor has been connected in the Satellite settings combo-box. |
| 3. | Closer or opener |  | Tick the Closer or Opener tickbox. |
| 3. | Closer or opener |  | Click the Update satellite settings button. |



If you have proceeded correctly, the **(Application)** column shows the name of the registered sensor.

7.3 Connecting Sensors

7.3.1 Connecting a Flow Sensor

The flow sensor measures the current flow-through value and displays it on the screen of the **Irrigation > Parameters > Edit** menu.

The flow value measured at a given moment is documented on the screen of the **Reports > Irrigation > Irrigation programs** menu.

This flow value serves for comparing with the theoretical values defined and their optimising. It also works as a safety device: should the max./min. limit flow be exceeded/not achieved, the pump station switches off. This could happen in the event of a leaking pipe or a pump running against a closed shut-off valve.



Please follow producer's installation and operation instructions for sensors. Do not activate any devices that have not been installed!

Wiring diagram

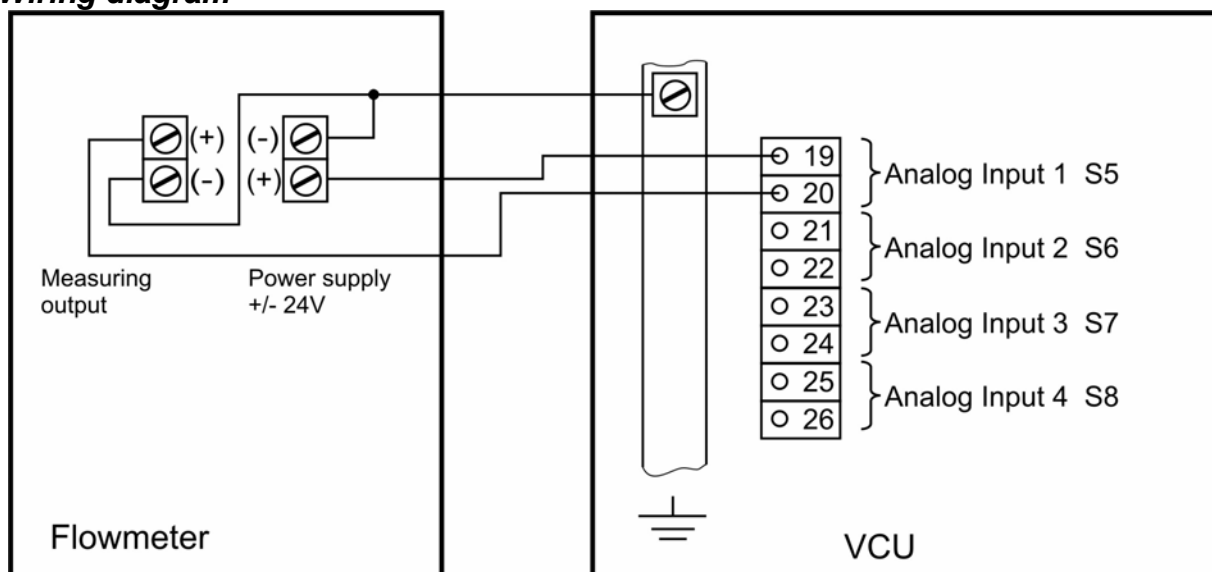

Connecting Example:

Flow meter type: Kobolt turbine-gear flow meter with integrated converter
Type TUR 2... .
Option A, output 0-20 mA

Metering: The nominal metering range (e.g. 2-80 m³/h) is linearly detected and converted into a 0-20 mA signal. This means that 1 mA = 4 m³/h.

Scale: The scale value is 4.0.



The voltage drops from 24 V to approx. 17 V in case of the maximum flow (here 80 m³/h). Voltage between the grounding and the pin No. 20 increases by the same value.



Alternatively you can check the correct functioning of the metering converter by checking the voltage between pins 19 and 20 on the VCU.

To register flow sensor values in the software, proceed as follows:

In the main menu:

1.	Setup	Settings
	Satellites	Go to the Setup > Satellites > Settings menu.







The screenshot shows the 'Settings' window for a satellite. On the left is a navigation menu with options like 'Course', 'Satellites', 'Hydraulics', 'Valves', 'Options', 'User', 'Programs', 'Irrigation', 'Reports', 'Service', and 'Logout'. The 'Satellites' section is selected. The main area shows 'Satellite selection' with a dropdown set to 'Master'. Below is a 'Sensor inputs' table:

	(Application)	(Scale)	(Offset)
S3	Closer	N/A	N/A
S4	Opener	N/A	N/A
S5	Q/I Flow	0.0	0.0
S6	P/I Pressure	0.0	0.0
S7	V/I Wind speed	0.0	0.0
S8	XY/I	0.0	0.0
S9	Frequency 1	0.0	0.0
S10	Frequency 2	0.0	0.0

At the bottom of the window are 'Print' and 'Save' buttons. A red arrow in the screenshot points to the 'Scale' field for S5, which contains the value 0.0.

2.	Satellite	↓	Choose the satellite to which the flow meter is connected.
----	-----------	---	--

3.	Scale		Click the Scale field in the S5 Q/I Flow line.
----	-------	---	--

4.		<p>Key in the calculated scale value.</p> <p> Calculate the scale value as described above.</p>
5.	<p>Save</p>	<p>Click the Save button.</p>
	<p>Print</p>	<p>Click the Print button to print all the entered parameters by means of a connected printer.</p>

7.3.2 Connecting a Pressure Sensor

The flow sensor measures the current pressure value and displays it on the screen of the **Irrigation > Parameters > Edit** menu.

The pressure value measured at a given moment is documented on the screen of the **Reports > Irrigation > Irrigation programs** menu.

With the help of these values, you can check that no unacceptable pressure peaks occur during irrigation start up or during opening/closing of valves. In addition to this, you can check that the overall pressure in the system is not too low/high and if so, you can decide whether to increase/decrease the flow to correct the situation. It also works as a safety device: should the max./min. limit flow be exceeded/not achieved, the pump station switches off. This could happen in the event of a leaking pipe or a pump running against a closed shut-off valve.



Please follow producer's installation and operation instructions for sensors. Do not activate any devices that have not been installed!

Wiring diagram

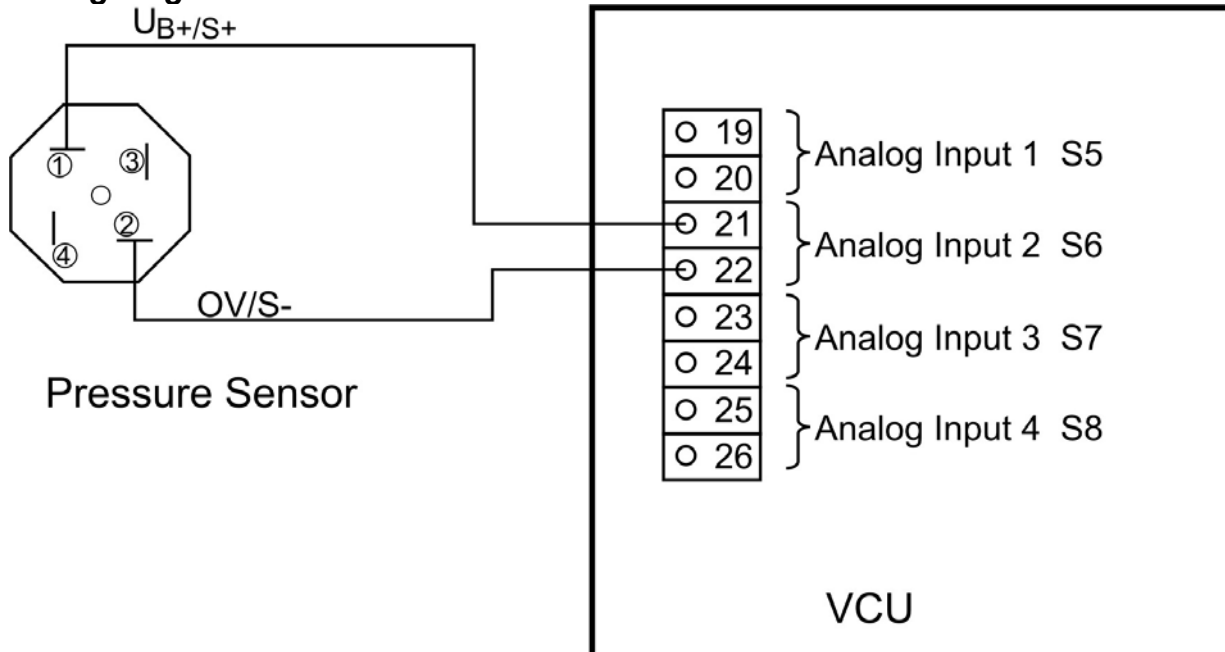

Connecting Example:

Pressure sensor type: Kobolt, type 3373.078.092
Output 4-20 mA
Measuring range 0-25 bar

Measuring: The nominal metering range (e.g. 0-25 bar) is linearly detected and converted into a 4-20 mA signal. This means that 1 mA = 1.56 bar.

Scale: The scale value is 1.56

Offset: The offset value is -6,24



You can check the correct functioning of your pressure sensor in the **Service > General** menu. The left column displays the current values on analog outputs. If your pressure sensor is connected according to the above diagram, the **Analog 2** line should display a value of 4 mA. If no value appears there, check the connection polarity. Then check whether the displayed values in mA change together with pressure changes. If they do, then the pressure sensor is connected correctly.

To register a pressure sensor, proceed as follows:



In the main menu:

1.	Setup	Settings
	Satellites	Go to the Setup > Satellites > Settings menu.



2.	Satellite	↓	Choose the satellite to which the pressure sensor is connected.
----	-----------	---	---



3.	Scale		Click the Scale field in the S6 P/I Pressure line.
----	-------	---	--

4.			Key in the calculated scale value. <i>Calculate the scale value as described in the above example.</i>
----	---	---	---

5.	Save	Click the Save button.
----	------	-------------------------------

Registering the offset value

6.	Offset		Click the Offset field in the S6 P/I Pressure line.
----	--------	---	---

7.			Key in the calculated offset value. <i>Remember that the minus sign needs to be included some cases, [-]6.24, for example.</i>
----	---	---	--

8.	Save	Click the Save button.
----	------	-------------------------------

	Print	Click the Print button to print all the entered parameters by means of a connected printer.
---	-------	--

7.3.3 Connecting an Anemometer (Wind Sensor)

With the help of this sensor (anemometer), you can learn, whether you should interrupt your irrigation process due to a strong wind causing great losses.



Please follow producer's installation and operation instructions for sensors. Do not activate any devices that have not been installed!

Wiring diagram

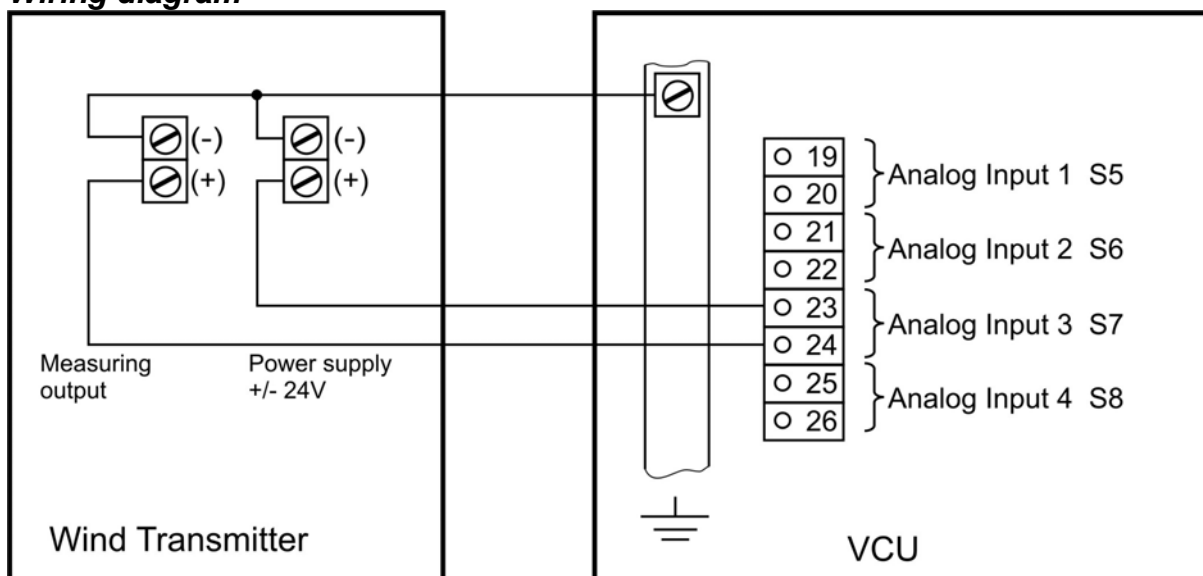

Connecting Example:

Wind sensor type:

Thies – Clima company
Windgeber - compact
Ord. No.: 4.3519.00.141
Output: 4-20 mA
Range: 0-50 m/s

Measuring:

As specified on the anemometer
0 – 50 m/s converted into a 4 – 20 mA linear signal

Scale:

Based on these values, the scale value can be calculated, which is to be entered in the S7 line in the **Setup > Satellites > Settings** menu.

$$\text{Scale: } \frac{50 \text{ m/s}}{(20 - 4) \text{ ma}} = 3.125 \frac{\text{m}}{\text{mas}}$$

Then calculate the offset value, which is also to be entered in the S7 line in the **Setup > Satellites > Settings** menu.

$$\text{Offset: } 4 \text{ mA} \times 3.125 \frac{\text{m}}{\text{mas}} = -12.5$$

By this, you have entered all the necessary values for *Perrot Satellite* to measure the wind speed and to record it on the screen of the **Irrigation > Schedule > Edit** menu.







To register the wind sensor values, proceed as follows:

In the main menu:

1.	Setup	Settings
	Satellites	Go to the Setup > Satellites > Settings menu.



	(Application)	(Scale)	(Offset)
S3	Closer	N/A	N/A
S4	Opener	N/A	N/A
S5	Q/I	Flow	0.0
S6	P/I	Pressure	0.0
S7	V/I	Wind speed	0.0
S8	XY/I		0.0
S9	Frequency 1		0.0
S10	Frequency 2		0.0

- | | | | |
|---|---|---|--|
| 2. | Satellite | ↓ | Choose the satellite to which the wind sensor is connected. |
| 3. | Scale |  | Click the Scale field in the S7 V/I Wind speed line. |
| 4. |  | | Key in the calculated scale value.
 Calculate the scale value as described in the above example. |
| 5. | Save | | Click the Save button. |
| 6. | Offset |  | Click the Offset field in the S7 V/I Wind speed line |
| 7. |  | | Key in the calculated offset value. |
| 8. | Save | | Click the Save button. |
|  | Print | | Click the Print button to print all the entered parameters by means of a connected printer. |

7.4 Irrigation Control by External Sensors/Devices

The external devices (sensors) display measured climatic parameters or technical values when the system is in the passive mode. These include:

- ✓ precipitation
- ✓ wind speed
- ✓ pump pressure
- ✓ flow
- ✓ custom-defined values.

If these external sensors are activated, you can use them to interrupt the irrigation process in the event of exceeding the predefined maximum values.

To activate an external sensor, tick the checkbox of the required sensor (S3 to S8).

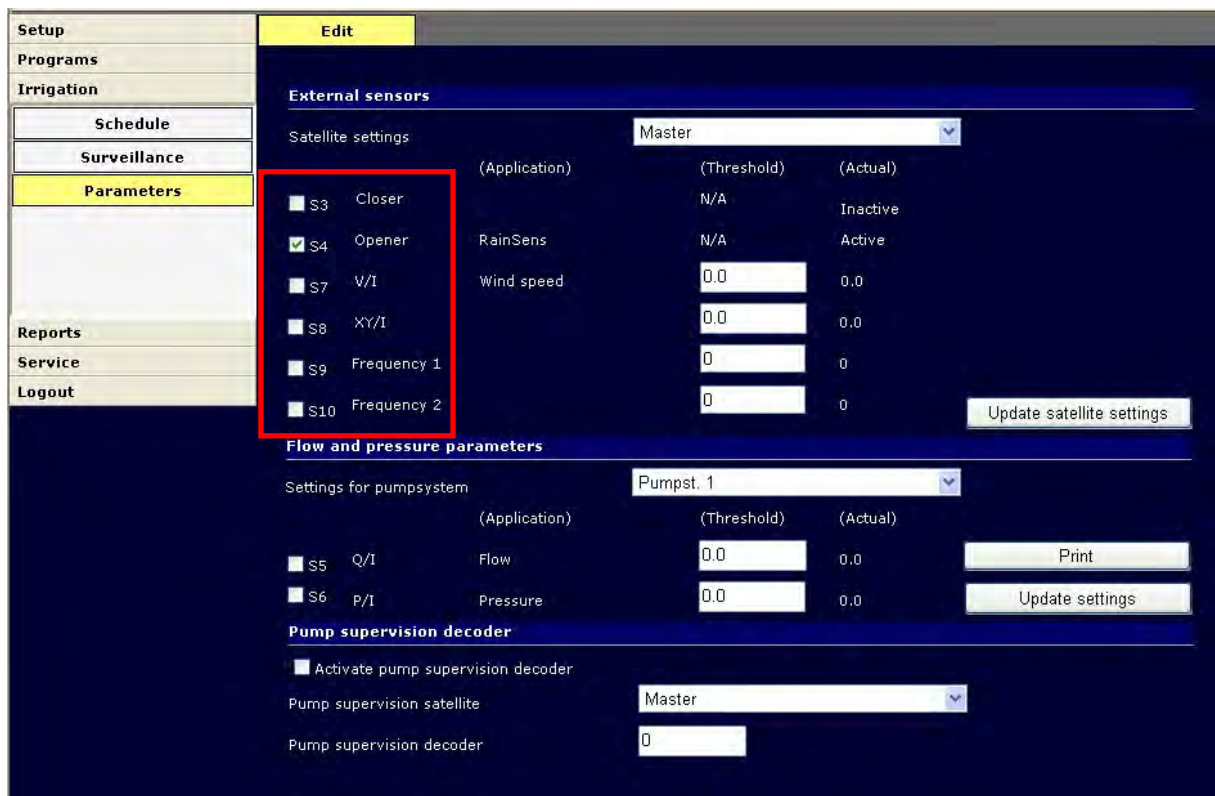

Sensor ID	Application	Threshold	Actual
S3	Closer	N/A	Inactive
<input checked="" type="checkbox"/> S4	Opener	N/A	Active
S7	V/I	0.0	0.0
S8	XY/I	0.0	0.0
S9	Frequency 1	0	0
S10	Frequency 2	0	0

Editing the settings



- ✓ Note: Activated sensors must have previously registered their names, their scale and offset values.
- ✓ Make sure that you define realistic limit values. Otherwise the irrigation would be interrupted unnecessarily.

7.4.1 External Sensors for a Weather Station

Sensors S3, S4, S7, S8, S9 and S10 have been designed for climatic parameter metering.

S3 and S4: digital inputs for rain sensors (see chapter 7.2)

S7 and S8: analog inputs for wind sensors (see chapter 7.3)

S9 and S10: frequency inputs, which can be used for wind sensors among others (see chapter. 7.3).



Mean values are calculated by *Perrot Satellite* from values received through analog or frequency inputs, so that random short-term excess of the limiting values does not interrupt irrigation.

However, an automatically running program does interrupt if the limiting value of a predefined active sensor is exceeded.

The irrigation status shows: "interrupted by weather station" if irrigation is interrupted by the rain or wind sensor.

Then *Perrot Satellite* checks the time entered in the ***Weather parameter timeout (min)*** field (see also chapter 7.2) if it can resume the irrigation, provided the value is back below the limit:

If so: Irrigation resumes, provided that this time shift (delay) does not cause overlapping with the next planned irrigation program. Should this be the case, the original program pauses and the next planned program runs first.

If not: The program pauses and the next planned program only starts after the measured value drops below the limit.

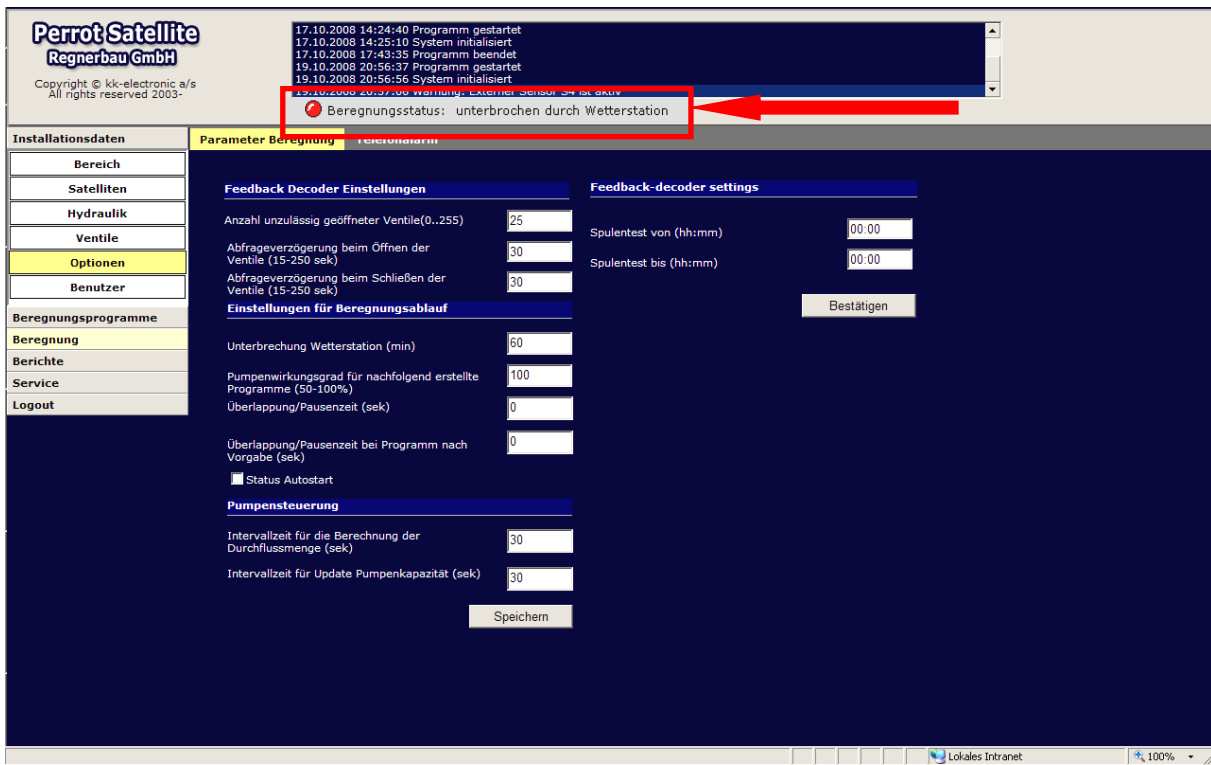

The screenshot shows the Perrot Satellite control software interface. At the top left, the company logo and name are displayed. A log window at the top right shows a list of system events. A red box highlights a specific log entry: "Berechnungsstatus: unterbrochen durch Wetterstation". Below the log, the main interface is divided into several sections: "Installationsdaten", "Parameter Berechnung", "Feedback Decoder Einstellungen", "Feedback-decoder settings", "Einstellungen für Berechnungsablauf", and "Pumpensteuerung". Each section contains various configuration parameters with input fields and buttons like "Bestätigen" and "Speichern".

Acceptable values: 0 – 999 min

Standard: 60 min.



The weather station does not consider manually opened valves or manually started programs. Do not activate any sensors that have not been installed!

7.4.2 External Sensors for Device Monitoring (S5/S6)

S5 and S6 are analog inputs for flow and pressure sensors (see chapter 7.3).

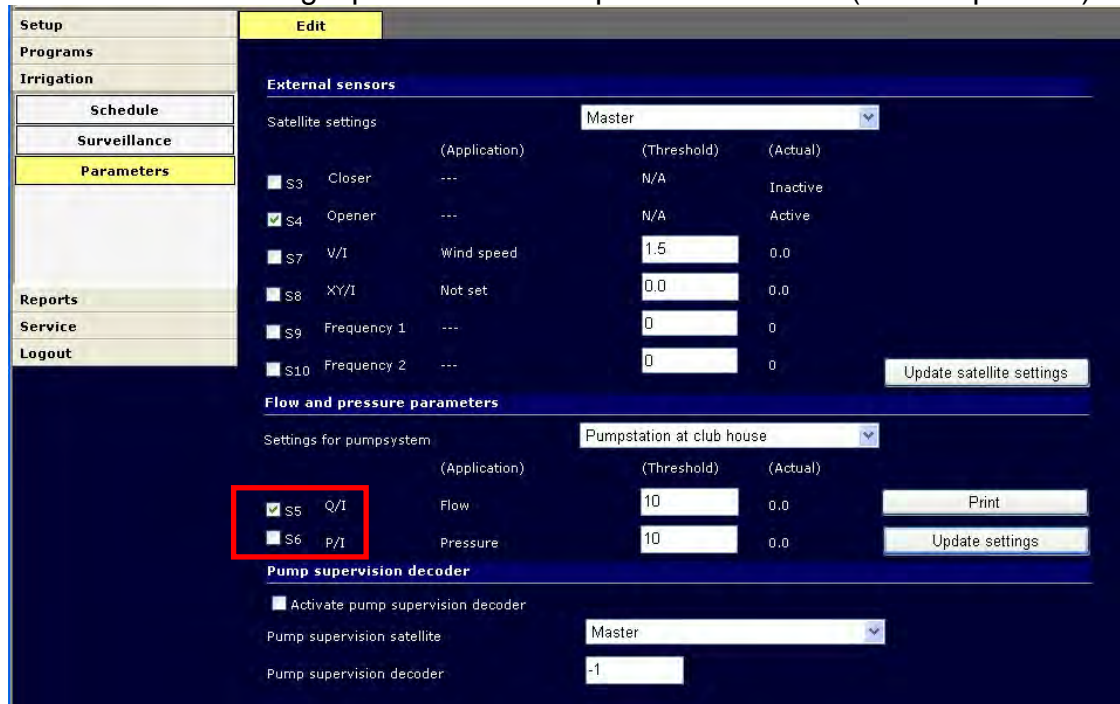

The screenshot shows the 'Edit' configuration page for external sensors. It is divided into two main sections: 'External sensors' and 'Flow and pressure parameters'.

External sensors section:

- Satellite settings: Master
- Table with columns: (Application), (Threshold), (Actual)
- S3 Closer --- N/A Inactive
- S4 Opener --- N/A Active
- S7 V/I Wind speed 1.5 0.0
- S8 XY/I Not set 0.0 0.0
- S9 Frequency 1 --- 0 0
- S10 Frequency 2 --- 0 0
- Buttons: Update satellite settings

Flow and pressure parameters section:

- Settings for pumpsystem: Pumpstation at club house
- Table with columns: (Application), (Threshold), (Actual)
- S5 Q/I Flow 10 0.0
- S6 P/I Pressure 10 0.0
- Buttons: Print, Update settings

Pump supervision decoder section:

- Activate pump supervision decoder:
- Pump supervision satellite: Master
- Pump supervision decoder: -1

Limiting value, editing the settings



- ✓ Note: Activated sensors must have previously registered their names, their scale and offset values.
- ✓ Make sure that you define realistic limit values. Otherwise the irrigation would be interrupted unnecessarily.

If limit values are exceeded in sensors S5 or S6, it has probably been caused by a mechanical defect in the equipment (broken pipe, close shut-off valve, faulty valve, etc.). Irrigation is interrupted in such a case (to protect the equipment and the pump station).

The irrigation status line shows: "Error S5/S6"



Irrigation is interrupted only if the limit value has been exceeded for more than 60 sec.

The system error displays in the red-highlighted line under the **Service > Error handling > Acknowledge** menu.

You can reset the error only by clicking the **Acknowledge all** button. This restarts the VCU and deletes the error.



Obviously you have to detect the source of the error and remove it first.

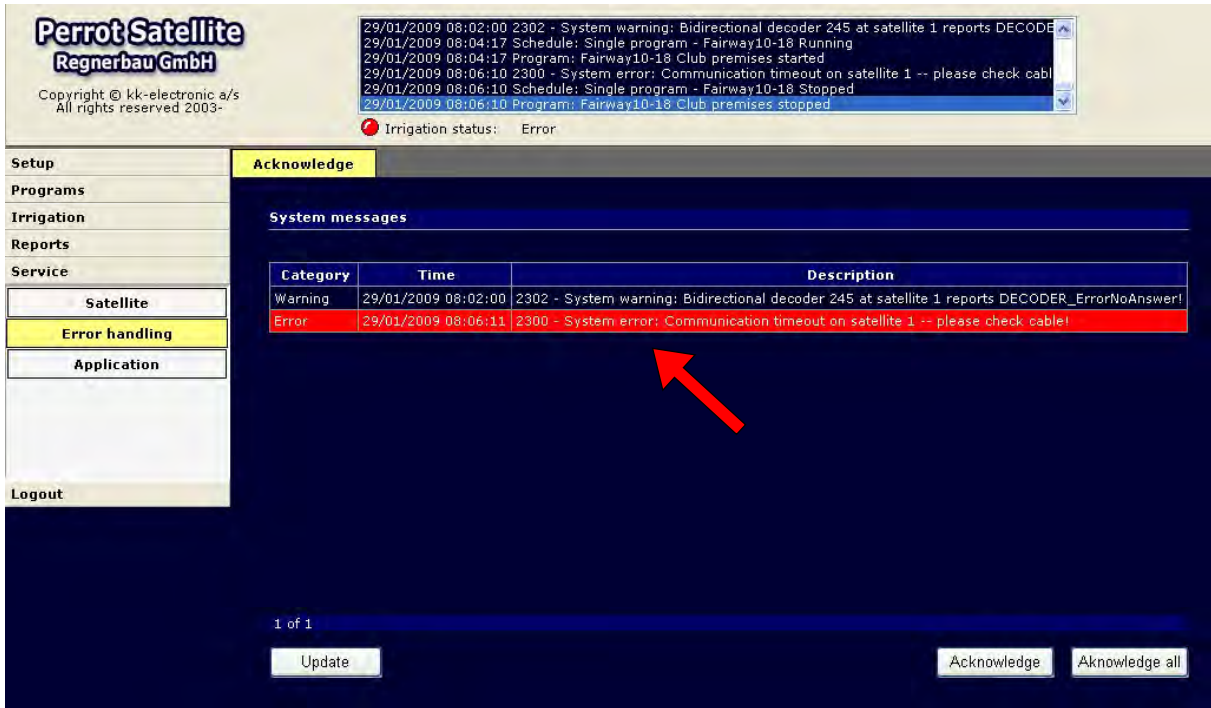

Perrot Satellite
Regnerbau GmbH
Copyright © kk-electronic a/s
All rights reserved 2003-

29/01/2009 08:02:00 2302 - System warning: Bidirectional decoder 245 at satellite 1 reports DECODE
29/01/2009 08:04:17 Schedule: Single program - Fairway10-18 Running
29/01/2009 08:04:17 Program: Fairway10-18 Club premises started
29/01/2009 08:06:10 2300 - System error: Communication timeout on satellite 1 -- please check cabl
29/01/2009 08:06:10 Schedule: Single program - Fairway10-18 Stopped
29/01/2009 08:06:10 Program: Fairway10-18 Club premises stopped

Irrigation status: Error

Setup
Programs
Irrigation
Reports
Service

Satellite
Error handling
Application
Logout

Acknowledge

System messages

Category	Time	Description
Warning	29/01/2009 08:02:00	2302 - System warning: Bidirectional decoder 245 at satellite 1 reports DECODER_ErrorNoAnswer!
Error	29/01/2009 08:06:11	2300 - System error: Communication timeout on satellite 1 -- please check cable!

1 of 1

Update Acknowledge Acknowledge all

Accept all

7.5 Pump Monitoring for Errors

The pump station control may be equipped with an overall error reporting system. The moment the pump station switches off for whatever reason, a general error is reported.

Thanks to the pump monitoring feature, this error can be reported to the *Perrot Satellite* software through a bidirectional decoder.

7.5.1 Setting the Pump Monitoring

To set the hardware for pump monitoring, proceed as follows:

- ✓ Bidirectional decoder programmed with the number 245.
- ✓ Closing relay at the pump control. The relay must operate in the following way:

- No errors – contact is open
- General error – contact is closed

No errors at Pump System:

- ✓ The pump-state-signalling relay has the contact **open** and the bidirectional decoder measures resistance values on the blue and red loop cables higher than 1000 Ohm. This state is registered by the system as **Pump OK**.

State: No errors

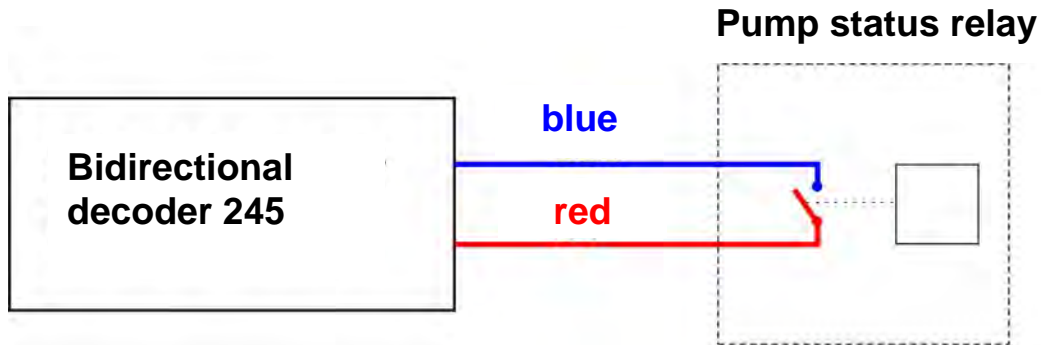

Error at Pump System:

- ✓ The pump-state-signalling relay has the contact **close** and the bidirectional decoder measures resistance values on the blue and red loop cables lower than 10 Ohm. This state is registered by the system as **Pump error**.

State: General error

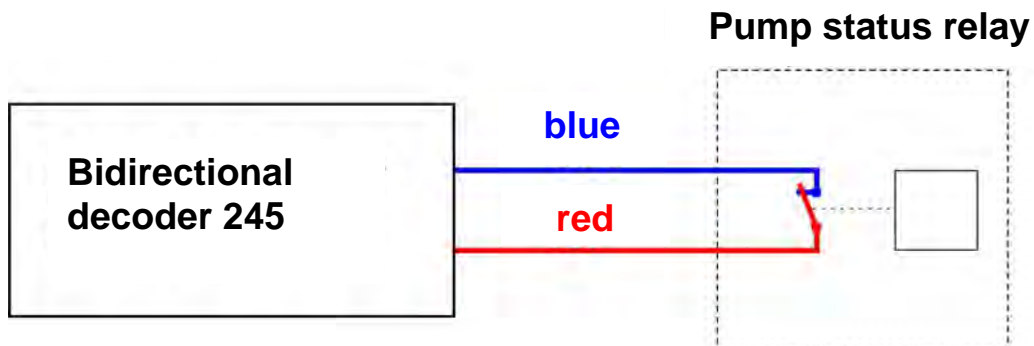

To use this functionality, the following data must be entered:

In the main menu:

1.	Irrigation	Edit
	Parameters	Go to the <i>Irrigation > Parameters > Edit</i> menu.

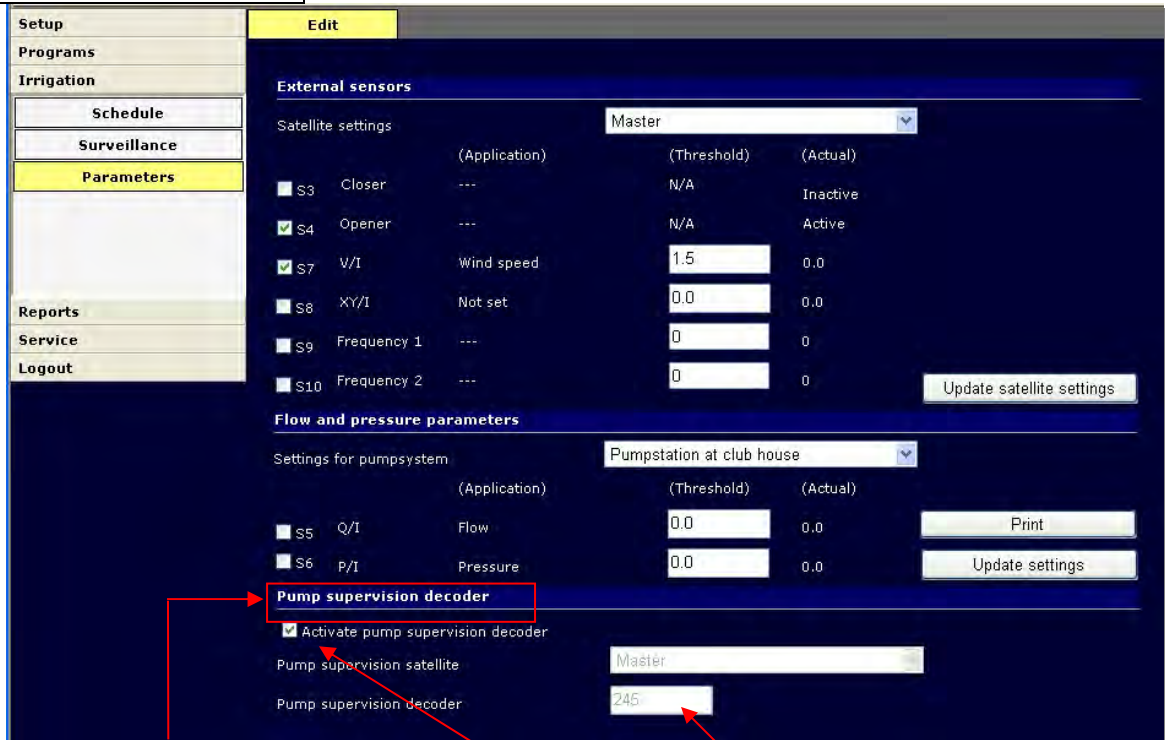

Pump supervising decoder activate Enter decoder number

- | | | | |
|----|-----------|---|--|
| 2. | Satellite | ↓ | Choose the satellite to which the decoder is connected. |
| 3. | | | Key in the number of the decoder installed to supervise the pump. |
| 4. | Activate | | Activate the function by ticking the Activate pump supervision decoder tickbox. |





7.5.2 Emergency Call in Case of Pump Error

Should a pump error occur, you can have it reported by phone. To set up the emergency call function, proceed as follows:

In the main menu:

1.	Setup	Emergency call
	Options	Go to the Setup > Options > Emergency call menu.



2.	Phone number		Click the Phone number data field.
3.			Key in the required telephone number.
4.	Save		Click the Save button.
5.	Test call		Check the connection by clicking the Test call button.



- ✓ The phone connection works only if your PC is connected to the Internet.
- ✓ The called party receives only a call – no voice message.

8 Graphic Overview

8.1 Description

Perrot Satellite offers a graphic presentation of the irrigated area under the **Irrigation > Surveillance** menu. The displayed area is scaleable, the picture has to be provided in dwg format.

Your dwg picture needs to be converted into svg format by the "Dataslinger" program. Then the svg file can be installed in Perrot Satellite as described in chapter 8.2.

Regnerbau Calw GmbH can prepare such a graphic form of irrigated areas for its customers based on their raw materials and send them the final svg file(s) back on a CD.

Interactive valve symbols (icons) can be placed on the graphic image by the user. These symbols indicate closed/open valves according to the particular irrigation program. In addition, the user can activate (open) a chosen valve manually by clicking its icon.



Active irrigation station:

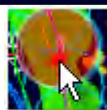

Passive irrigation station:

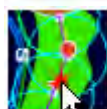

8.2 Converting and Inserting a Graphic Image



You need to have *technician* rights to insert graphic images in *Perrot Satellite*.

8.2.1 Converting Graphic Files

After you receive a graphic file(s) of your area to be irrigated from your project designer (on a CD, for example), you have to convert and insert this graphic image in *Perrot Satellite*. Do the following:

- ✓ Start *Perrot Satellite*
- ✓ Start *Satellite Browser*
- ✓ Insert medium with graphic data (CD) in your PC
- ✓ Maximise the *Perrot Satellite* window

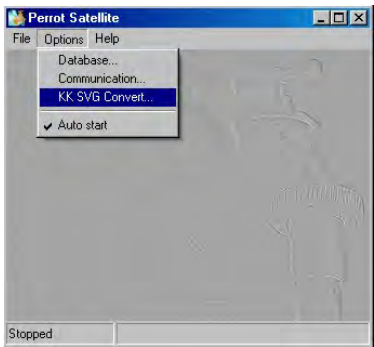
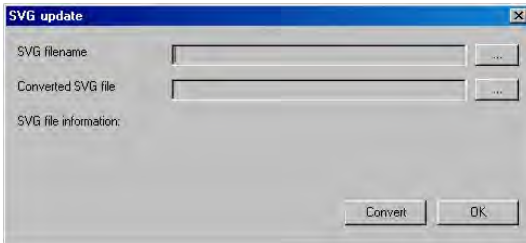
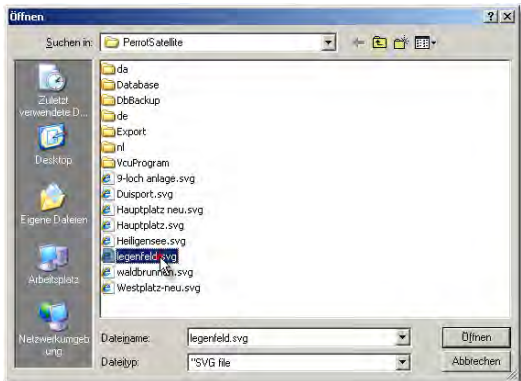
1.	Options menu	Go to the Options > KK SVG Convert menu.	
2.	KK SVG Convert	Click the SVG file field. A dialog box opens.	
3.	Choose file	Find your SVG file containing your graphic image and click it.	

4. Open SVG file Click the **Open** button.

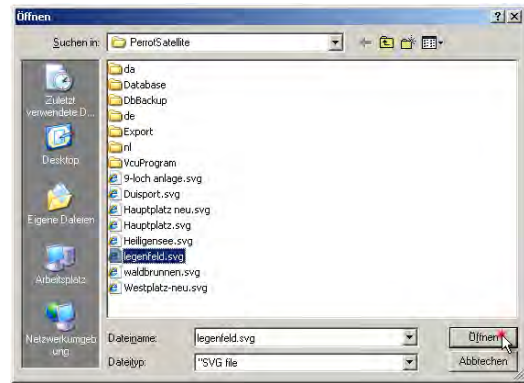

5. Convert The dialog box automatically offers the target directory where the converted file will be saved.

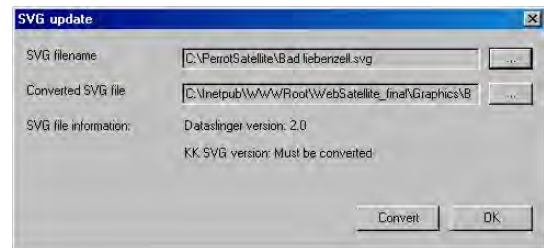

This directory must not be changed!

6. Convert Click the **Convert** button.

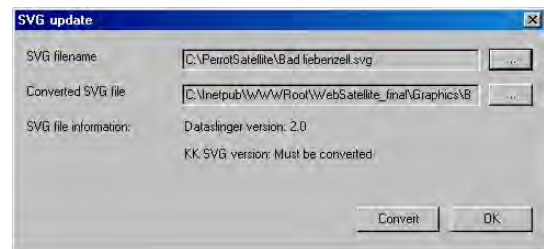

7. Finish This information box opens after the conversion is successfully completed. Confirm it by clicking the **OK** button.



8.2.2 Inserting a Graphic Image



You need to have *technician* rights to insert graphic images in *Perrot Satellite*.

In the main menu:

1.	Setup	Settings
	Course	

Go to the **Setup > Course > Settings**

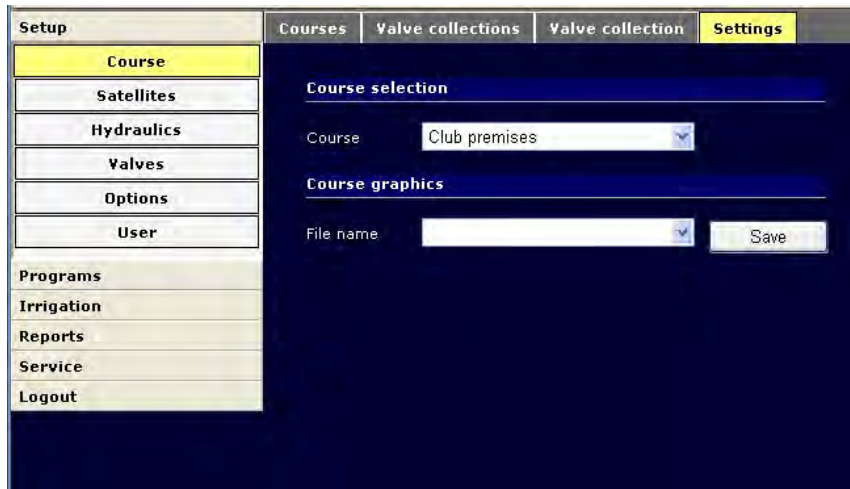

The screenshot shows a web-based interface with a dark blue background. On the left is a vertical menu with options: Setup, Course (highlighted), Satellites, Hydraulics, Valves, Options, User, Programs, Irrigation, Reports, Service, and Logout. The main content area has tabs for 'Courses', 'Valve collections', 'Valve collection', and 'Settings' (selected). Under 'Settings', there is a 'Course selection' section with a dropdown menu showing 'Club premises'. Below that is a 'Course graphics' section with a 'File name' dropdown menu and a 'Save' button.

2.	Course	↓
----	--------	---

Choose the course to which you want to assign a graphic image in the **Course** combo-box.

3.	File Name	↓
----	-----------	---

Choose the corresponding graphic image file in the **File name** combo-box and save it by clicking the **Save** button.



Only converted SVG files saved in the "C:\\inetpub\\wwwroot\\websatellite_final\\graphics" can be selected!

8.3 Placing Valve Icons in Graphic Image

To place valve symbols, proceed as follows:

In the main menu:

1.	Irrigation	Overview
	Surveillance	

Go to the **Irrigation > Surveillance > Overview** menu.

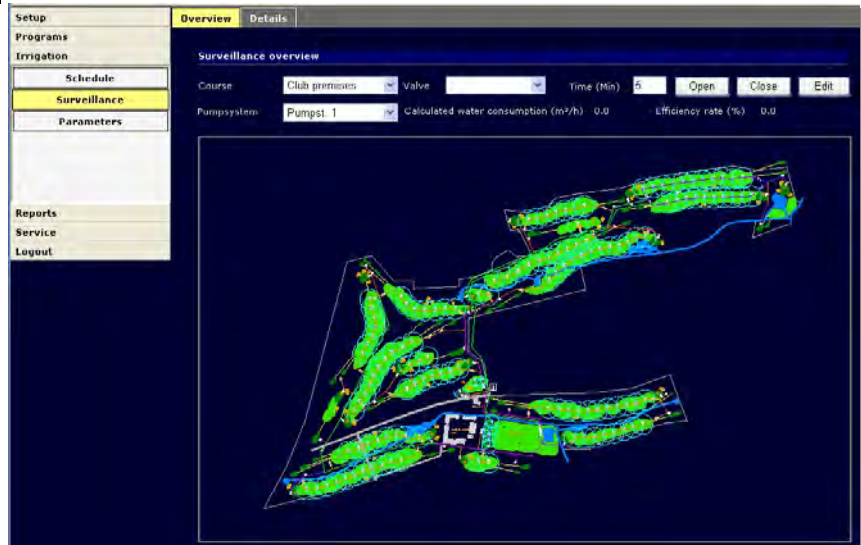

2.	Course	↓
----	--------	---

Choose the course to which you want to place valve icons in the **Course** combo-box.

3.	Edit	
----	------	--

Click the **Edit** button
All valves of this course will be written in the **Valve** combo-box.

4.	Valve	↓
----	-------	---

Choose the valve you want to place in the graphic image by clicking it in the **Valve** combo-box.

5.	Add	
----	-----	--

Click the **Add** button.



The valve icon appears in the top left picture corner.

6.	Position valve icon	
----	---------------------	--

Click the valve icon and drag it (i.e. click and keep the mouse button pressed) to the required position in the image.



If you want to zoom the image in, keep the Ctrl key on your keyboard pressed and mark the part of the image you want to enlarge with the mouse, having its left button pressed. Once you release the mouse button, the marked area appears as the enlarged image (a cut-out from the original image).



Marked area for enlarging (zooming in)



Enlarged cutout



You can move the zoomed cutout on the screen by holding the Alt key on your keyboard pressed and by clicking the image and dragging it in the required direction.



If you want to reduce the enlarged image, click it with the **right** mouse button, and choose **Zoom out** or **Original View** in the context menu. This will zoom the image out – back to the original size (scale).

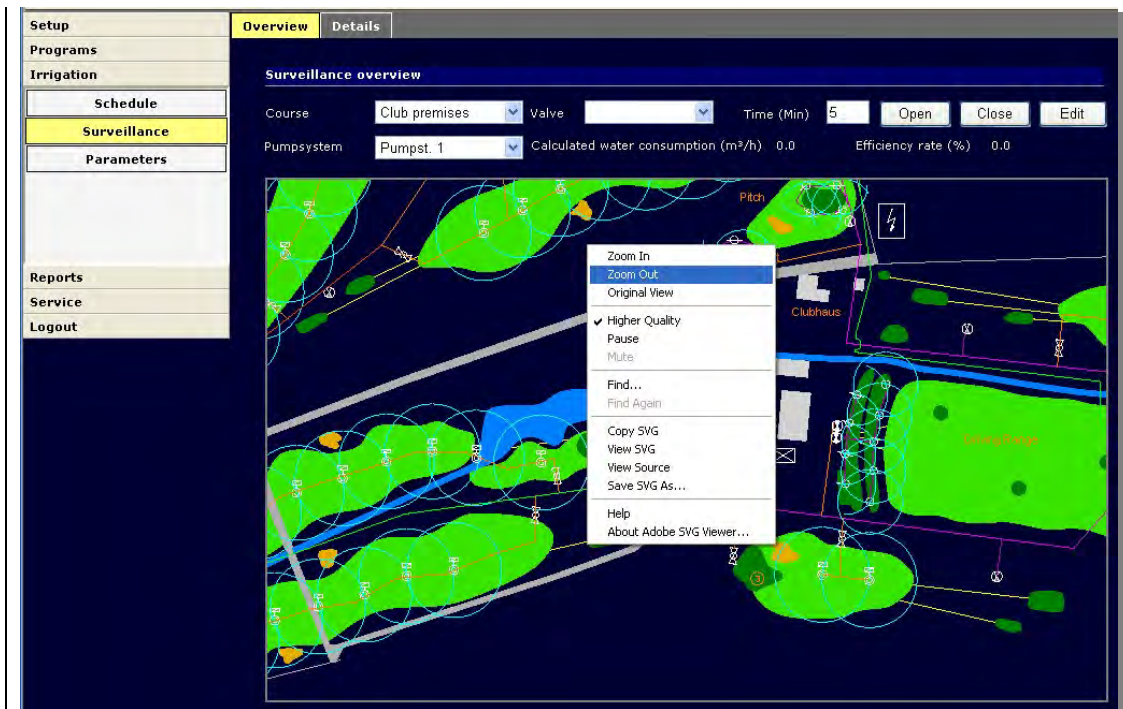

Once you have placed all the valves in the image, you can leave the editing mode.

8.

Overview

Exit the editing mode by clicking the **Overview** button.

8.4 Manual Opening of Individual Valves

1.	Irrigation	Details
	Surveillance	

Go to the **Irrigation > Surveillance > Overview** menu.

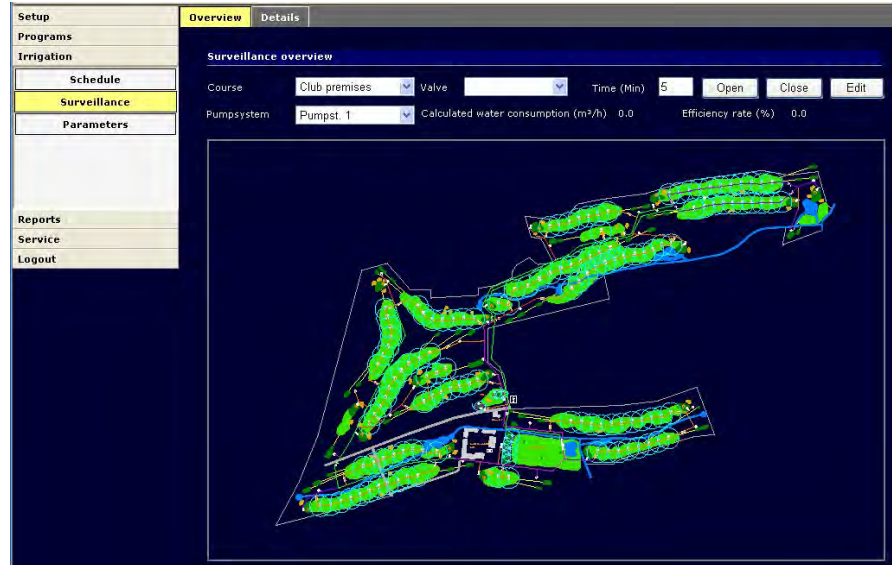

2.	Valve	↓
----	-------	---

Choose the valve you want to open manually.

- 1.) Click the **Valve** combo-box and choose the required valve.
- or
- 2.) Click the required valve icon in the graphic image.



Only valves positioned in the graphic image are listed in the **Valve** combo-box.

3.	Time (min)
----	------------

Key in the required time (duration) for the selected valve to stay open.

4.	Open
----	------

Click the **Open** button. This opens the valve for the duration as specified in the **Time (min)** field.

5.	Close
----	-------

Click the **Close** button. This closes the valve immediately.

8.5 Displaying the Current Valve Status

Once you choose a pump system, **Calculated water consumption** displays its value, which is the sum of all active valve consumptions. The **Efficiency rate** informs of the relative pump use compared to its nominal performance. It should not exceed 100% for a prolonged period.

Pump system Calculated water consumption Efficiency rate.

8.6 User Information on Irrigation Process

The **Irrigation > Surveillance > Details** menu informs the user of all steps performed as part of the currently running irrigation program.

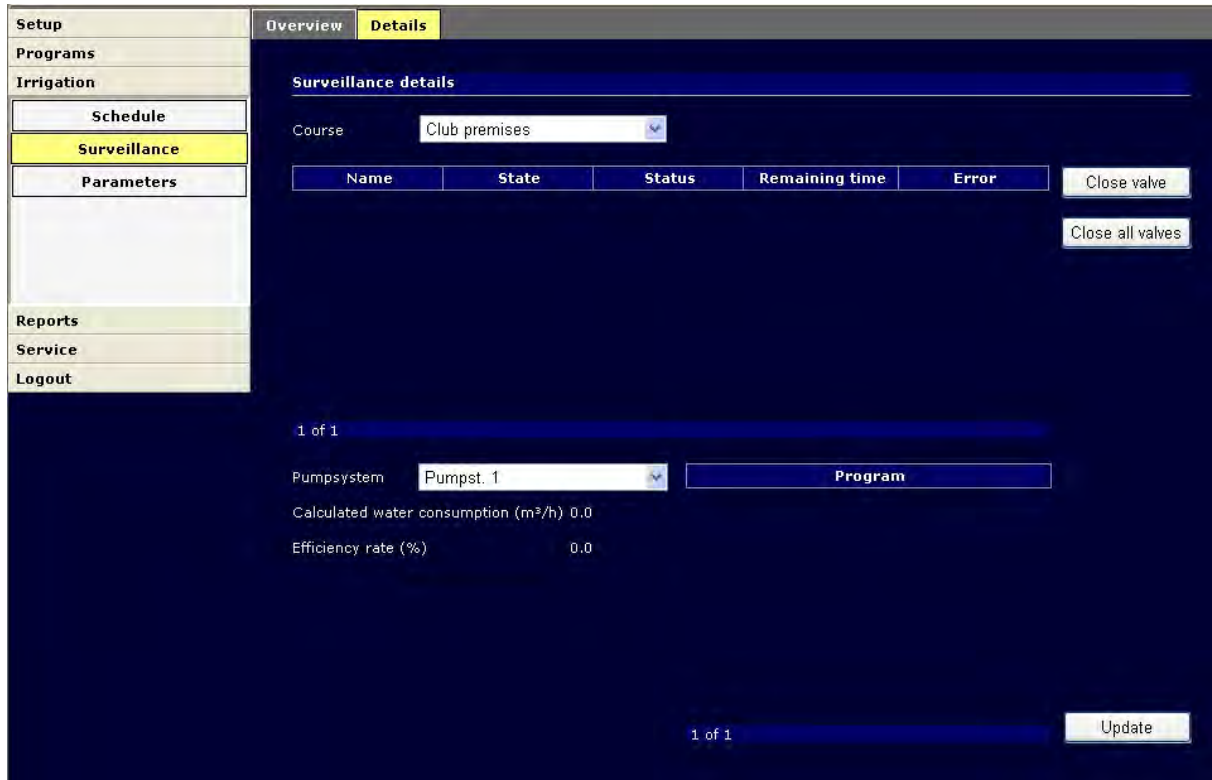

Course (down arrow)	↓	Choose the course for which you want to see information about the currently running program.
Name		This column shows the valve name.
State		This column shows whether the valve is open or closed.
Status		"Auto" if the valve is opened by the program "Manual" if the valve is opened manually in the graphic image, through a transmitter or from a PDA.
Remaining time		This column shows the remaining time for which the valve is to be open.
Error		Error reporting – only with bidirectional decoders.
Program		This column lists all the currently running irrigation programs at all courses.
Pumpsystem		See chapter 8.5.

Close valve

By clicking this button, you can close the valve selected in the table immediately, regardless of its remaining time.

Close all valves

By clicking this button, you can close all the currently open valves.



In order to see the current system state on this screen, you have to click the *Update* button. Only then will the latest state appear.

9 Remote Access from the Internet

9.1 Description and Communication Diagram

Perrot Satellite is irrigation control software built on the Internet technology platform. Thanks to this program architecture, the software can easily be operated through a web browser (Internet Explorer, for example) and can be operated remotely. The software is installed on a control PC which works as a server.

Remote access from another PC (desktop or laptop) is possible through:

- ✓ Internet with a fixed IP address of the server PC or through the "dyndns.org" service.

Remote access from a PDA is possible through:

- ✓ the Internet (GPRS, for example).

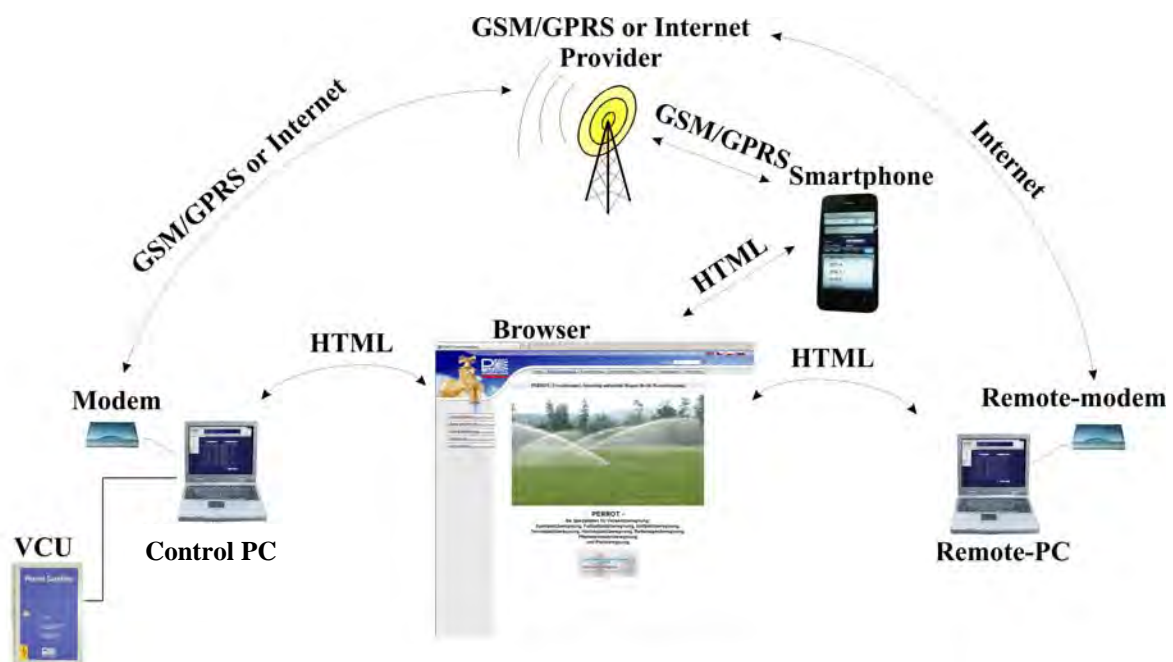

9.2 Remote PC Hardware and Software Requirements

- ✓ Min. AMD Athlon 64 or Intel Pentium 4, min. 1GHz
- ✓ Min. 1,024 GB RAM, approx. 40GB free hard disc space
- ✓ Windows XP Professional SP2 with Net Framework and IIS installed
- ✓ Microsoft Internet Explorer 6.0.28 or newer
- ✓ Network card: Ethernet 100 Mbit
- ✓ VGA colour monitor, resolution 1024 x 768
- ✓ laptop wide resolution 1280 x 800

9.3 Perrot Satellite Remote Control over the Internet

Remote Control Conditions

- ✓ The *Perrot Satellite* server must be permanently connected to the Internet. A T-DSL Flatrate connection is recommended.
- ✓ The *Perrot Satellite* server must have a fixed IP address (can be bought for a low charge together with the T-DSL Flatrate connection).
- ✓ The server must have *Perrot Satellite* running (Internet Explorer, however, does not have to be open).
- ✓ Now you can access *Perrot Satellite* from a remote client PC (desktop or laptop) connected to the Internet. Type the following address in Internet Explorer:
[http://\[fixed IP-Address\]/WebSatellite_final/Login/PageStartLoginPC.aspx](http://[fixed IP-Address]/WebSatellite_final/Login/PageStartLoginPC.aspx)
where [fixed IP-Address] is the fixed IP address given to you by your internet provider.
- ✓ **Perrot Example**
For demonstration purposes, let's try to establish a connection to the internal Perrot server:
http://87.139.50.247:10000/WebSatellite_final/Login/PageStartLoginPC.aspx



Your Internet access should be set up by your system administrator.

You can perform all activities and use all functions of *Perrot Satellite* through the Internet as you would do them directly on the control PC, i.e. without any limitations.

9.4 Perrot Satellite Remote Control over from PDA

9.4.1 Establishing a Connection

Perrot Satellite can also be controlled from a PDA connected to the Internet. Type the following address in Internet Explorer:

[http://\[fixed IP-Address\]/WebSatellite_final/Login/PageStartLoginPDA.aspx](http://[fixed IP-Address]/WebSatellite_final/Login/PageStartLoginPDA.aspx)
where [fixed IP-Address] is the fixed IP address given to you by your internet provider.

You can perform all the control functions from your PDA such as opening/closing of valves, auto on/off, and learn system status information. These functions are important especially if checking/controlling the system in the field. You cannot enter any valve data from a PDA.

9.4.2 Manual Valve Opening from PDA

The most important function for the field control is opening of individual valves. It is done as follows:



Through the **web'n'walk** function, open Internet Explorer in your PDA and establish a connection with your *Perrot Satellite* server.

Enter your username and password and click the **Login** button.



It is recommended to set the link to *Perrot Satellite* either as your homepage or save it as one of your favourite links.



Choose the **Single valves** option in the main menu.



To speed the valve selection up, click the Select function.

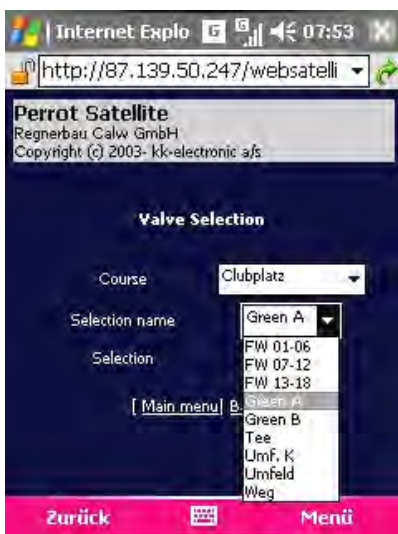

Using the  key, you can now choose one of the Selection names previously saved in the server PC.



If you want to see *Green A* in the **Valve selection** menu, for example, you have to tick the **Selection** tickbox.

All ticked selection names will be displayed in Manual control and in Valve selection, as well as valves with **no** selection name.



Note: The window must be redefined after each selection, i.e. after each click. If you click too quickly, not all defined selections may save properly.



Once you have all names selected, keep clicking the Back function, until you return to the Manual control page.



Using the  key, you can select all ticked valves with selection names as well as valves without a selection name.

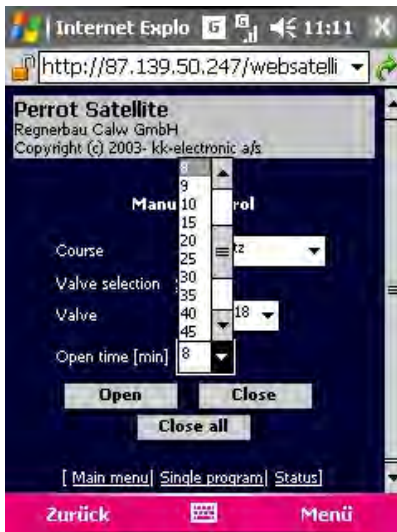

Once you have a valve selected, you can set the time for which the valve should stay open.

Use the  key.



Click the **Open** button to open the valve immediately. Should you want to close the valve prematurely, click the **Close** button. If you have opened more valves and want to close them all, click the **Close all** button.



Use the "Zoom" submenu to enlarge the data to the required size.



Other PDA menus such as Auto control, Error handling and Status information operate the same way as in the main software and therefore do not require further explanation.

9.5 *Perrot Satellite* Checklist for Internet Remote Access

Hardware and Software Requirements

- Min. AMD Athlon 64 or Intel Pentium 4, min. 1GHz
- Min. 1,024 GB RAM, approx. 40GB free hard disc space
- Windows XP Professional SP2 with Net Framework and IIS installed
- Microsoft Internet Explorer 6.0.28 or newer
- RS 232 (COM1) serial port for connecting the VCU
- Network card: Ethernet 100 Mbit
- VGA colour monitor, resolution 1024 x 768
- Laptop wide resolution 1280 x 800

Remote Control Conditions

- The *Perrot Satellite* server must be permanently connected to the Internet. Recommended is a T-DSL Flatrate connection.
- The *Perrot Satellite* server must have a fixed IP address (can be bought for a low charge together with the T-DSL Flatrate connection).
- The server must have *Perrot Satellite* running (Internet Explorer, however, does not have to be open).
- Now you can access *Perrot Satellite* from a remote client PC (desktop or laptop) connected to the Internet. Type the following address in Internet Explorer:
[http://\[fixed IP-Address\]/WebSatellite_final/Login/PageStartLoginPC.aspx](http://[fixed IP-Address]/WebSatellite_final/Login/PageStartLoginPC.aspx)
where [fixed IP-Address] is the fixed IP address given to you by your internet provider.
- Perrot Satellite* can also be accessed from a PDA connected to the Internet. Type the following address in Internet Explorer:
[http://\[fixe IP-Adresse\]/WebSatellite_final/Login/PageStartLoginPDA.aspx](http://[fixe IP-Adresse]/WebSatellite_final/Login/PageStartLoginPDA.aspx)
where [fixed IP-Address] is the fixed IP address given to you by your internet provider.

- ❑ If you do not have a permanent IP address established, you can access *Perrot Satellite* using the "DynDNS" service (more information at <http://www.dyndns.org>). If you have a professional router available, this router will provide an automatic IP address update through the "DynDNS" service. If you do not have a professional router, you have to use the "DynDNS Updater" program to update the IP address.

- ❑ **Perrot Example**
For demonstration purposes, let's try to establish a connection to the internal Perrot server:
http://87.139.50.247:10000/WebSatellite_final/Login/PageStartLoginPC.aspx

10 Transmitter

10.1 Remote control via the transmitter TM1

The hand terminal consists of a 2 x 16-stelligen digital display and 7 function keys. The communication as well the power supply occurs by the 2-wire decoder cable. The plug has to be connected with the field connector.

The transmitter provides following functions:

- ⇒ Valve open
- ⇒ Valve immediately close
- ⇒ All valves immediately close

The transmitter will be connected with the 2-wire cable system via the field connector.

After the transfer of the station names the Transmitter can be used at all field connectors.



Clear identification of the valve names by text Indicator e.g. 18 – Green 9

After setting the valve opening time the Transmitter can be disconnect from the field connector.

Information call informs you about:

- ⇒ Irrigation status
- ⇒ Condition of each decoder (open/close)
- ⇒ Emergency stop function – to switch off all irrigation activities

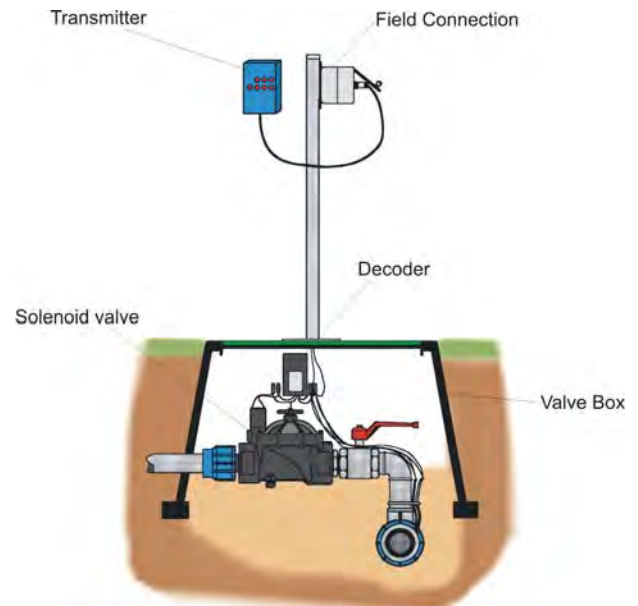

You can find further details in the user manual TDP063e (Transmitter TM1).

10.2 Remote control via Wireless Transmitter

The WT allows the communication with the control system about an autarkic radio network. The radio network will be installed at site (see picture – scheme drawing). With a free view to the antenna a coverage up to 2km is possible. If there is any obstacle due to the area, buildings or trees you can expand to the requested coverage with the installation of additional repeater stations. The WT can be used in all European countries without radio license.

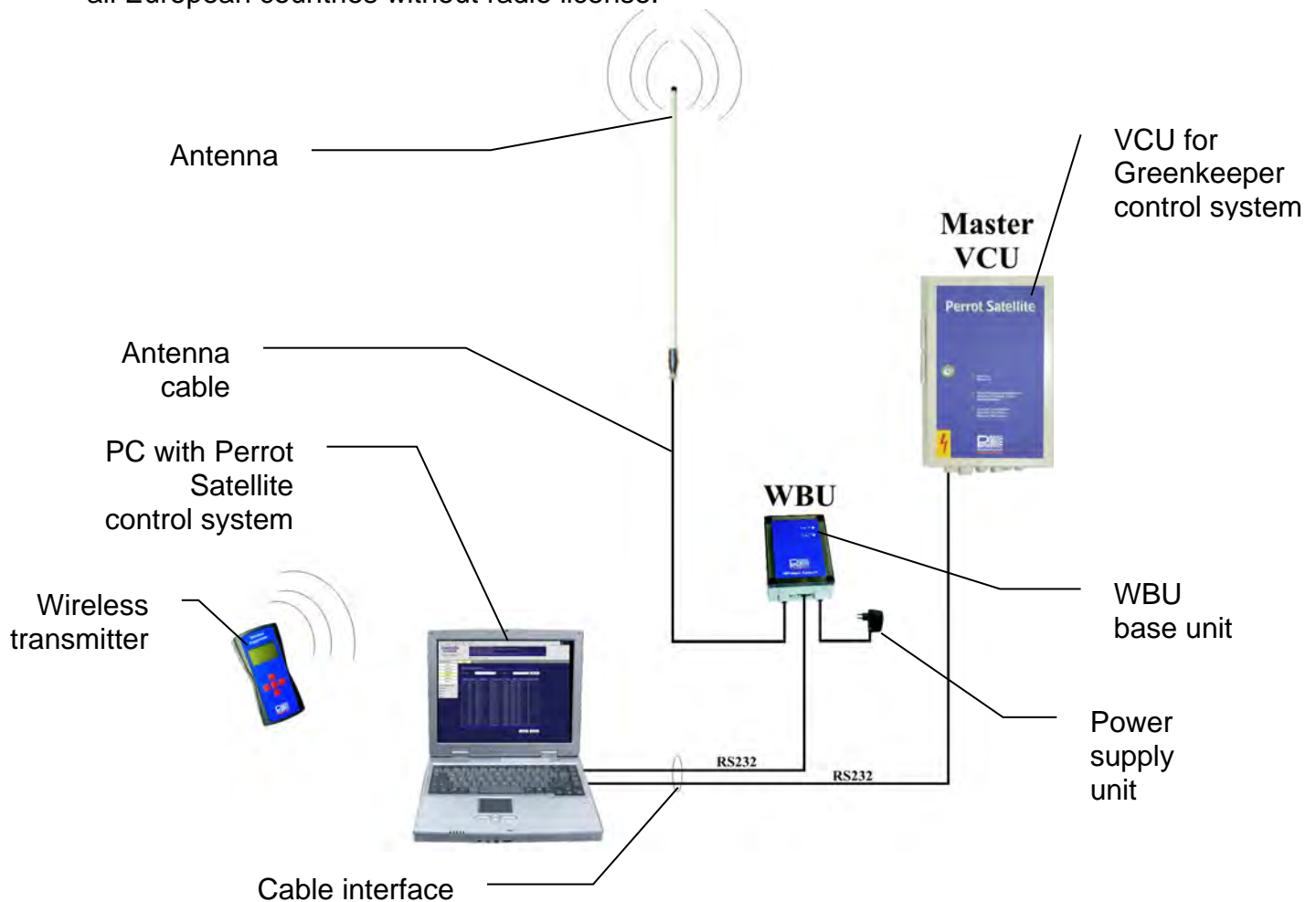

Application

The WT is very robust and easy to use with just 5 buttons. Ideal for manual watering and for function tests of the system.

Functions

Open and close the valves with adjustable time standards. Start and stop the irrigation programs.

Easy valve searching by choosing different criteria. Automatic synchronisation of the valve- and program data, 3-digit LCD display for menu navigation and super support.



You can find further details in the user manual TDP061e (Wireless Transmitter for Perrot Satellite).

11 Reports

All irrigation steps are saved in the PC. *Perrot Satellite* software can process the data of these steps and provide them in the form of various reports.

There are three types of reports available:

11.1 Irrigation Reports

1. Irrigation Program Report

The report lists all valve activities that occurred in the last programs.

Irrigation Program Report

Course name	Club premises	28/01/2009 20:07:32
Report name	[2009-01-28 19:31:41][Fairway10-18]	
Start Time	2009-01-28 19:31:41	S9 0.00
Stop Time	19:33	S10 0.00

Position	State	Valve name	Time	Valve status	S5 flow	Estimated flow	Pressure
1	On	FW 18-1	28/01/2009 19:31:59	OK			
2	On	FW 17-1	28/01/2009 19:31:59	OK			
3	On	FW 10-1	28/01/2009		0	54.00	0.00

Course name:	The name of the course
Report name:	Irrigation program name
Start time:	Starting time of the irrigation program
Stop time:	Time of finishing the irrigation program
S9:	Name and value of frequency input 1
S10:	Name and value of frequency input 2
Position:	Sequential No. 1-1600 (480 per Single/Sector program)
State:	Valve status, 2 per valve, on/off
Valve name:	Name of the valve
Time:	Time at which the reported event happened
Valve status:	This reports correct [OK] or erroneous valve status (in case of bidirectional decoder)
S5 flow:	Report from a V/I flow meter If a flow meter is installed, this reports the real flow at the given moment.
Estimated flow:	Flow as calculated from the entered data.
Pressure:	Report from a P/I pressure meter If a pressure meter is installed, this reports the real pressure in bars at the given moment

2 Yearly Report

This report lists the overall precipitation, water consumption and opening time for each valve in the whole year.

Irrigation Report

Course name **Club premises** 28/01/2009 20:09:51
Year **2009**

Valve	Density (mm)	Consumption (m ³)	Active Time (hh:mm)
FW 10-1	0,00	0,66	0:01
FW 17-1	0,00	0,58	0:01
Total	0,00	1,24	0:02

3. Snapshot Report

This report lists all the currently active valves and irrigation programs.

11.2 Irrigation Program Report



All users can view and/or print these reports!

To display/print a report, proceed as follows:

1.	Reports Irrigation
----	-----------------------

Go to the **Reports > Irrigation > Irrigation programs** menu.

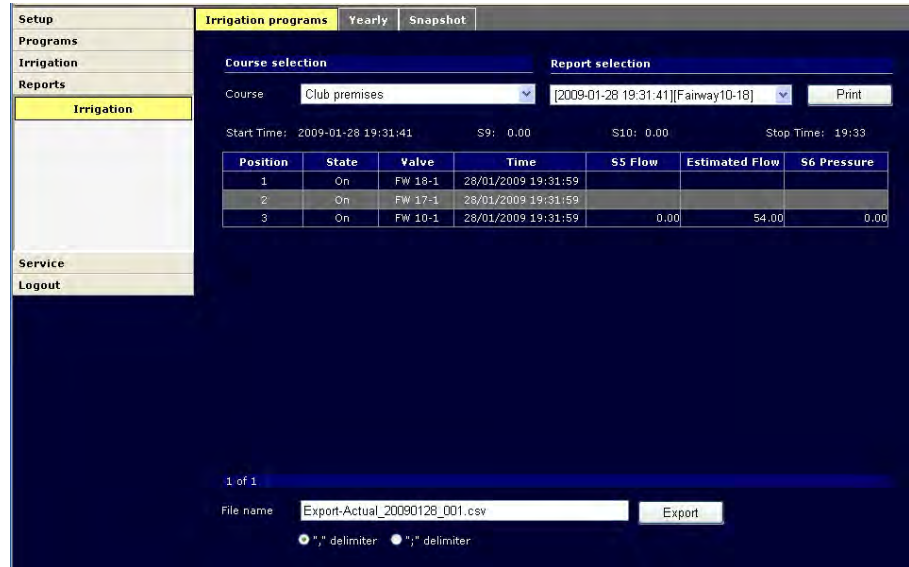

The screenshot shows the 'Irrigation programs' report interface. On the left is a navigation menu with 'Irrigation' selected. The main area has 'Course selection' (Club premises) and 'Report selection' ([2009-01-28 19:31:41][Fairway10-18]). Below this is a table of events:

Position	State	Valve	Time	S5 Flow	Estimated Flow	S6 Pressure
1	On	FW 18-1	28/01/2009 19:31:59			
2	On	FW 17-1	28/01/2009 19:31:59			
3	On	FW 10-1	28/01/2009 19:31:59	0.00	54.00	0.00

At the bottom, there is an 'Export' section with a file name field containing 'Export-Actual_20090128_001.csv' and a 'Print' button.

2.	Course	↓
----	--------	---

Choose the course for which you want to print your report.

3.	Report selection	↓
----	---------------------	---

Choose the irrigation program for which you want to print your report.



The report lists all changes of valve status (on/off).



The screen displays the selected course.
Each event is marked with a sequential number and valve information.



You can go to the following screen (page) by clicking the **Next** button.
You can go to the previous screen (page) by clicking the **Prev** button.

4.	Print
----	-------

Click the **Print** button to open the print preview of the report.

5.	
----	---

Click the printer button to print the displayed report in the printer connected to your PC.

11.3 Yearly Report



All users can view and/or print these reports!

To display/print a report, proceed as follows:

1.	Reports Irrigation
----	-----------------------

Go to the **Reports > Irrigation > Yearly** menu:



Valve	Density (mm)	Consumption (m³)	Active Time (hh:mm)
FW 10-1	0.00	0.93	0:02
FW 17-1	0.00	0.85	0:01
Total	0.00	1.78	0:03

2.	Course	↓
----	--------	---

Choose the course for which you want to print your report.

3.	Year	↓
----	------	---

Choose the year for which you want to print your report.



The screen displays the yearly report for the selected year.
The report displays the overall precipitation, water consumption and opening time for each valve – for the whole year.
The bottom **Total** line displays sums of all the above annual values.



You can go to the following screen (page) by clicking the **Next** button.
You can go to the previous screen (page) by clicking the **Prev** button.

4.	Print
----	-------

Click the **Print** button to open the print preview of the report.

5.	
----	---

Click the printer button to print the displayed report in the printer connected to your PC.

Data Export



You need to have **technician** rights to backup data from **Perrot Satellite**.



You can export the selected report in a different format. Once your data is exported in the **.CSV** format, you can open your report and edit it in MS Excel, for example.



1.	Export
----	--------

Click the **Export** button to save the selected report as an **.CSV** file.

2.	Saving
----	--------

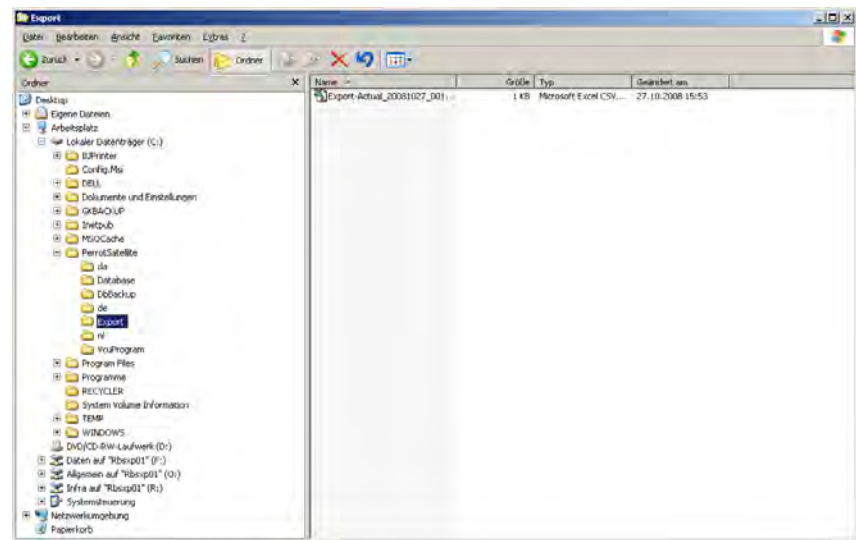

The exported **.csv** file will be saved in the **C:/PerrotSatellite/Export/** directory.



Individual values can be separated (delimited) with a comma or with a semicolon in the exported **.csv** file. When you then open the file in MS Excel, you have to specify the separator used.

3.	Excel
----	-------

Now you can open your exported file in Microsoft Excel.

11.4 Program/Valve Snapshot

To display the active irrigation programs and valves, proceed as follows:

In the main menu:

1.	Reports	<table border="1" style="width: 100%;"> <tr> <td style="width: 30%; text-align: center;">Snapshot</td> <td style="width: 70%;"> </td> </tr> </table>	Snapshot	
Snapshot				

The **Program** column lists all currently running irrigation programs. The **Valve name** column lists all currently active valves.

- | | | |
|----|--------|---|
| 2. | Update | Click the Update button to update the lists on this screen. |
| 3. | Print | Click the Print button to open the print preview of the report. |
| 4. | | Click the printer button to print the displayed report in the printer connected to your PC. |

12 Data Backup

By means of the backup function, you can save all user-entered data (e.g. pump data, valve data) and software-related data (e.g. irrigation programs, interval values) in a single file located in a subdirectory under the *Perrot Satellite* directory.

In an emergency, you can restore the backed up data (i.e. load it back to the system), so that the irrigation system runs in the normal way again.

For this reason, it is vital to back up your data after each important change in the *Perrot Satellite* software (e.g. after a system data modification).

We recommend to also back up your data externally (to a CD or a USB flash disc) just in case your hard disc or the whole PC collapses.



Backup your data after each data modification!!!

12.1 Backing up Your Data

To backup your data, proceed as follows:

12.1.1 Stopping *Perrot Satellite* software

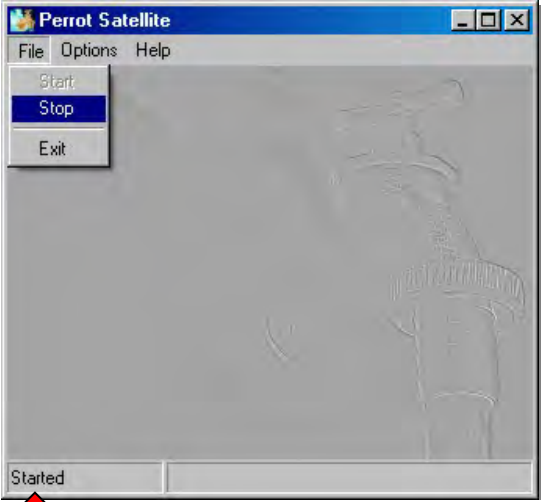
1.	<i>Perrot Satellite</i>	Stop <i>Perrot Satellite</i>
<p>Stop the software</p>		
		<p>Go to the File menu and click the Stop item.</p>
		<p>↑ Status</p>

2.	Stop the software
----	-------------------

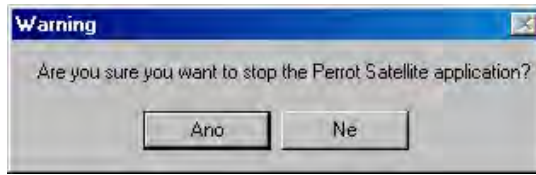

Click the **Yes** button.



Stopping the software takes some time. **Stopping...** appears in the status line in the bottom left corner of the Perrot Satellite window. The software is stopped at the moment this message changes into **Stopped**.

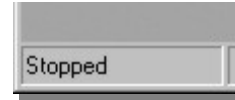

12.1.2 Executing the Backup Function

1.	<i>Perrot Satellite</i> Database menu
Choose data backup	

Go to the **Options > Database** menu.

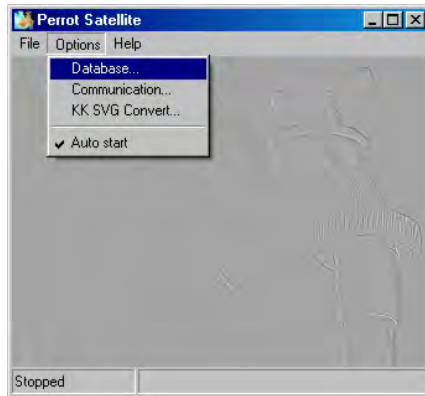

Go to the **Options** menu and click the **Database** item.

2.	Choose Backup
----	----------------------

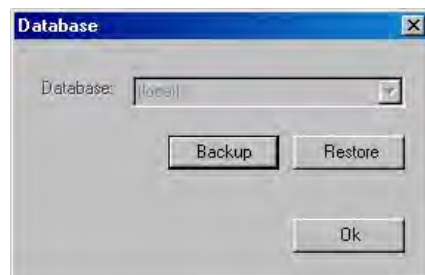

Click the **Backup** button.

3.	Choose file name and target directory
----	--

Choose a name and a directory for your backup file in the dialog box that opens.
The name of the file should always contain the date of its saving. We recommend not to change the proposed file name and target directory and to save the file with these settings.

4.	Save	
----	------	--

Click the **Save** button.
This creates a backup file [.bak] in the selected directory..

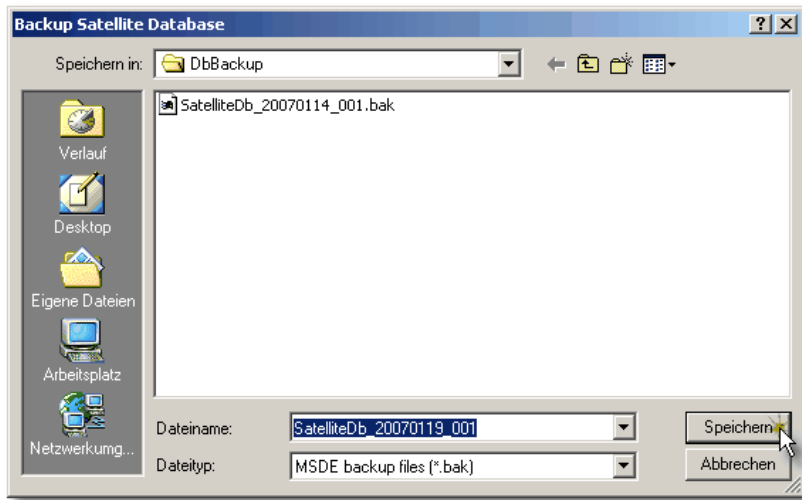

5.	OK
----	----

Leave the database menu by clicking the **OK** button.



To protect your data in case of your PC collapse, save it externally, too.

12.1.3 Starting *Perrot Satellite* software

1.	Start the software
----	--------------------

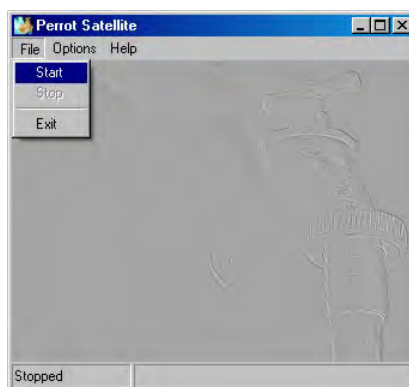

Go to the **File** menu and click the **Start** item.



Starting the software takes some time. **Starting...** appears in the status line in the bottom left corner of the *Perrot Satellite* window. The software is ready to work again at the moment this message changes into **Started**.

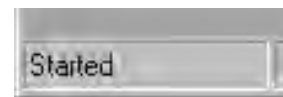

12.2 Restoring your Data

To restore your data from a backup file, proceed as follows:

12.2.1 Stopping *Perrot Satellite* software

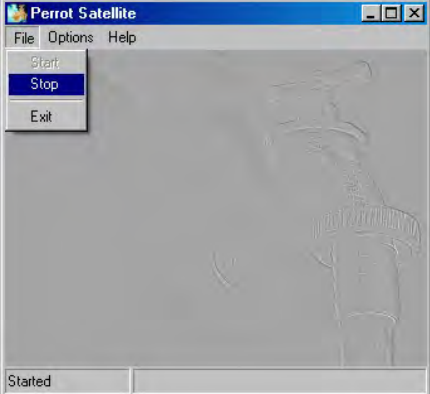
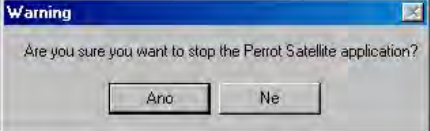
1.	<i>Perrot Satellite</i>	<p>Stop <i>Perrot Satellite</i></p> 	<p>Go to the File menu and click the Stop item.</p>
2.	Stop the software		<p>Click the Yes button.</p>



*Stopping the software takes some time. **Stopping...** appears in the status line in the bottom left corner of the *Perrot Satellite* window. The software is stopped at the moment this message changes into **Stopped**.*

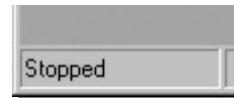

12.2.2 Executing the Restore Function

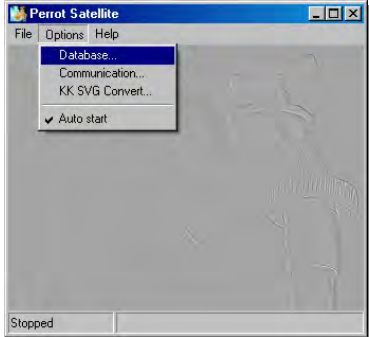
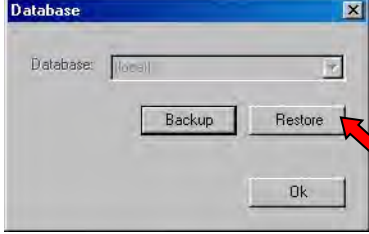
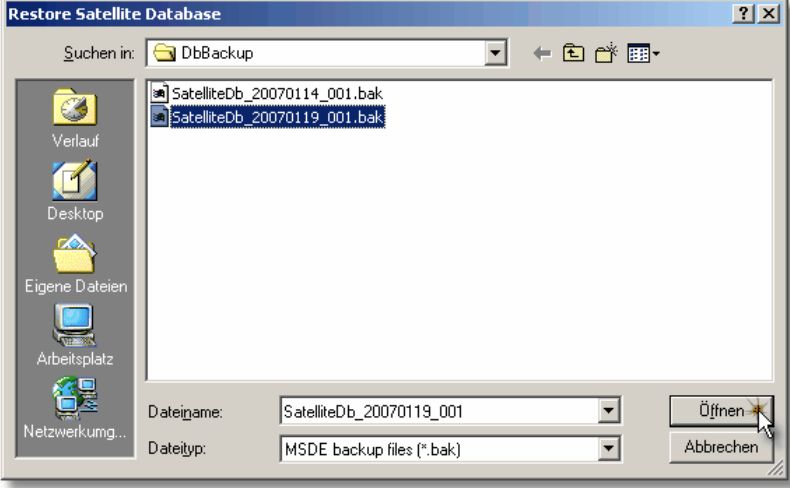
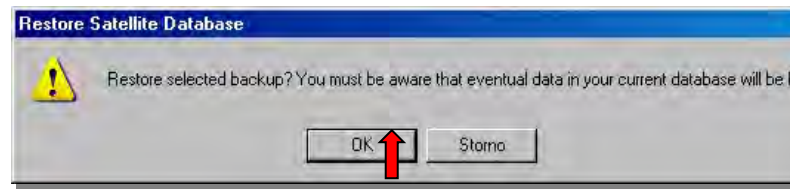
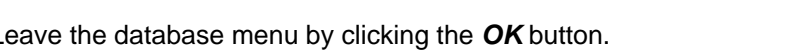
- | | | | |
|----|---|---|--|
| 1. | <p><i>Perrot Satellite</i>
Database menu</p> <p style="text-align: center;">Database</p> | <p>Go to the Options > Database menu.</p>  | <p>Go to the Options menu and click the Database item.</p> |
| 2. | <p style="text-align: center;">Choose Restore</p> |  | <p>Click the Restore button.</p> |
| 3. | <p style="text-align: center;">Choose directory and file name</p> | <p>Choose the latest file in the corresponding directory in the dialog box that opens. You can tell the latest file by its saving date.</p> |  |
| 4. | <p style="text-align: center;">Open</p> | <p>Click the Open button.
<i>Perrot Satellite</i> data will be restored from the selected backup file [.bak]. All the current software data will be overwritten.</p> |  |
| 5. | <p style="text-align: center;">Overwrite data?</p> | <p>Click the OK button.</p> |  |
| 6. | <p style="text-align: center;">OK</p> | <p>Leave the database menu by clicking the OK button.</p> | |

12.2.3 Starting *Perrot Satellite* software

1.	Start the software		Go to the File menu and click the Start item.
----	--------------------	---	---



Starting the software takes some time.
Starting... appears in the status line in the bottom left corner of the *Perrot Satellite* window.
The software is ready to work again at the moment this message changes into **Started**.

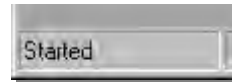

All the data and settings should be checked after a data restore!

13 Decoder

13.1 Decoder Programming



You need to have *technician* rights to program a decoder!



You must program each decoder to a correct address (number) before installing it.

Perrot Satellite allows you to freely choose decoder numbers for valves, pumps and pump monitoring. Yet, it is recommended to use the following numbering system to make it easier to survey:

Decoder number	1240	for valves
Decoder number	241 .. 250	for pumps
Decoder number	251	for pump monitoring

Decoder Types:

Description	Type code	Features	Application
Standard decoder	PD5/AC-1	Red square box, 4 connecting cables	To control 1 station
Decoder for 4 stations	PD5/AC-4	Red square box, 10 connecting cables	To control 4 stations
Decoder for 6 stations	PD5/AC-6	Red square box, 14 connecting cables	To control 6 stations
Bidirectional decoder	PDF/-1	Black square box, 4 connecting cables	To control 1 station with valve state feedback



All decoders can be reprogrammed as many times as needed.

A. To program a decoder, you need the following components:

- ✓ PC with the Perrot-Satellite software installed, and VCU
- ✓ DPG programming unit - FB (part No. ZH90022) or
DPK programming cable (part No. SG50032)
- ✓ Decoder

B. Preparation for decoder programming

Open the VCU door.

Plug the programming unit connector to terminals **34 and 35** on the VCU bus. The decoder cable (6-pole connector) must be disconnected.



Programming unit

Go to the **Service > Satellite > Decoders** menu.

In the main menu:

1.	Service	Decoders
----	---------	----------

Satellite

Setup	General	Decoders	Decoder test	Log	Programming
Programs					
Irrigation					
Reports					
Service					
Satellite					
Error handling					
Application					
Logout					

Satellite Master

1	2	3	4	5	6	7	8	9	10
11	12	13	14	15	16	17	18	19	20
21	22	23	24	25	26	27	28	29	30
31	32	33	34	35	36	37	38	39	40
41	42	43	44	45	46	47	48	49	50
51	52	53	54	55	56	57	58	59	60
61	62	63	64	65	66	67	68	69	70
71	72	73	74	75	76	77	78	79	80
81	82	83	84	85	86	87	88	89	90
91	92	93	94	95	96	97	98	99	100
101	102	103	104	105	106	107	108	109	110
111	112	113	114	115	116	117	118	119	120
121	122	123	124	125	126	127	128	129	130
131	132	133	134	135	136	137	138	139	140
141	142	143	144	145	146	147	148	149	150
151	152	153	154	155	156	157	158	159	160
161	162	163	164	165	166	167	168	169	170
171	172	173	174	175	176	177	178	179	180
181	182	183	184	185	186	187	188	189	190
191	192	193	194	195	196	197	198	199	200
201	202	203	204	205	206	207	208	209	210
211	212	213	214	215	216	217	218	219	220
221	222	223	224	225	226	227	228	229	230
231	232	233	234	235	236	237	238	239	240
241	242	243	244	245	246	247	248	249	250
251	252	253	254	255					

● Not installed

● Opening

● Open

● Closing

● Closed

Inrush current

Standard

Hold current

Standard

Program

Description

- ✓ Each point has a decoder number on the right-hand side. The meaning of different colours is explained on the right of the screen.
- ✓ Satellite choice: Choose the satellite, to which you want to connect the programming unit, in the **Satellite** combo-box.
- ✓ **Activate/deactivate** buttons: The selected decoder will be activated or deactivated by clicking the corresponding button.
- ✓ **Inrush/Hold current**: Depending on the characteristics of the coil switched by the decoder, higher or lower current must flow through the coil to provide reliable coil functioning.
- ✓ Electrical current values can be set at 4 levels: high, standard, medium or low. Depending on this setting, the decoder sends higher or lower level of the inrush or hold current to the coil.
- ✓ Do not exceed the recommended operating range described in the table in chapter 13.4, while programming.
- ✓ Use the **Program** button to program the decoder.

C. Programming with DPG Unit (part No. ZH05 90022)

1. Connect the programming unit to a new decoder.
Red cable to the red terminal
Blue cable to the blue terminal
Always 1 black cable to the black terminal.
2. Switch the unit controller to the central position.
3. Click the radio button of the required decoder number on the screen.
 By this, you have selected the required decoder. A black dot appears inside the radio button (i.e. the white circle).
4. Click the **Program** button.

The LED on the decoder turns on.



Ready to program

5. Wait for at least 2 seconds, then press the unit controller upwards to the "Program" position and keep it pressed for 2 seconds.
 By this, you have saved an address (a number) in the decoder.

The LED on the decoder should blink 5 times briefly.



Programming successful

Should the LED fail to respond, repeat the programming procedure starting with step 4.

To test the programmed decoder, press the unit controller downwards to the "Test" position.

Click the **Activate** button on the screen.

The decoder is activated when the LED on the unit (COIL ON) is on and the decoder blinks in the following rhythm:

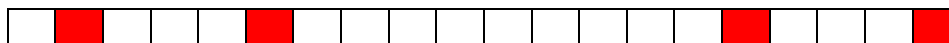

Decoder is active

To terminate, click the **Deactivate** button.

The decoder is now prepared for installation.

Do not forget to write the selected number on the decoder!!

To program further decoders, repeat the whole procedure.



If electrical current flows into a decoder for longer than 5 minutes, the programming protection turns on automatically. You can only continue programming after the decoder has been without the current for some time.

D. Programming with DPK Cable (part No. CGA9 50032)

Proceed the same way as in section C.

- ⇒ **Connect programming cable terminals with 1 black cable from the decoder.**
- ⇒ **Click the required number**
By this, you have selected the required decoder. A black dot appears inside the radio button (i.e. the white circle).
- ⇒ **Click the *Program* button.**

The LED on the decoder turns on.



Ready to program

- ⇒ **Wait for at least 2 seconds. Then interconnect the red and the blue decoder cables.**
Now you have saved the address (number) in the decoder.

The decoder LED should respond by 5 short blinks.



Programming successful

Should the LED fail to respond, repeat the whole programming procedure.



No functionality check can be done with the Programming cable. Should you need to perform a functionality check, you would have to connect a coil to the red and blue decoder cables.

To program further decoders, repeat the whole procedure.
Do not forget to write the selected number on the decoder!!



Standard decoder type: PD5/AC-X (incl. MultiDecoder)
Part No.: ZH05 90033 + ZH05 90377 + ZH05 90378
from production date: 12-04
is programmed the same way as the FB decoder.

This decoder type can also be reprogrammed as often as needed.

13.2 Programming Bidirectional Decoders

Bidirectional decoders are programmed the same way as standard decoders.

Warning: Once you connect the programming unit to the decoder, start programming as soon as possible. Otherwise the repeated error registration would find out that no coil has been connected, which could have negative effects on the programming process.

Normal operation

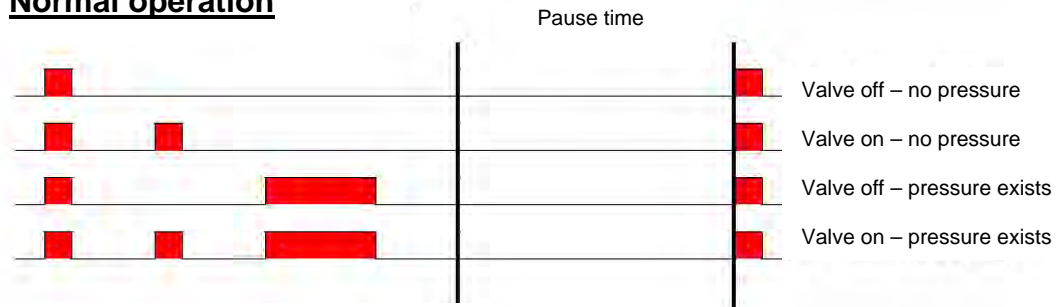

Operation with Error



13.4 Variable current values at standard decoders type PD2-5/AC for Greenkeeper Win and for Perrot Satellite

Current setting	1 High		2 Standard		3 Medium		4 Low		5 PD/AC-1	
	Holding power	I [ma]	Holding power	I [ma]	Holding power	I [ma]	Holding power	I [ma]	Holding power	I [ma]
1. Perrot coil 30 W										
1 coil (70m 2x1,5 ²)	1	8	1	7	1	5,5	1	4	1	5,7
2 coils in series (70m 2x1,5 ²)	1	7	1	6,3	1	5	2	3,2	1	6
3 coils in series (70m 2x1,5 ²)	1	6,3	1	5,7	1	4,4	2	2,7	1	6,5
2. WM coils 30 W										
1 coil (70m 2x1,5 ²)	1	11	1	10,5	2	8,5	3	6,5	1	7,5
2 coils in series (70m 2x1,5 ²)	1	10	1	9	2-3	7,4	4	-	2	6
3. Rain Bird coil 30 W										
1 coil (70m 2x1,5 ²)	1	9	1	7,8	2	6,3	3-4	4,5	1	7
2 coils in series (70m 2x1,5 ²)	3	8	4	7	4	6,5	3-4	4,2	4	6
4. Toro coil 25 W										
1 coil (70m 2x1,5 ²)	1	10,5	1	10	2	8	4	-	1	8,2
2 coils in series (70m 2x1,5 ²)										
1 coil (160m (90m 2x1,5 ² / 70m 2x1,0 ²))	1-2	13,5	3	11,5						
5. Burekert coil DC 50 W										
1 coil (70m 2x1,5 ²)	1	8,5	1	7,2	1	5,5	3	3,5	1	5,5
6. Richdel 811 coils 30 W										
1 coil (70m 2x1,5 ²)	1	11,5	1	9,2	2	9	2	7,5		
2 coils in series (70m 2x1,5 ²)	1	10	2	8	2	7,7	3	6,5		
<i>Remarks:</i>										
1. Current values measured on coil cable with current clamp										
2. Holding power: 1 very good, 2 ok, 3 poor, 4 bad										
3. Current Settings:										
High: 800/110 ma										
Standard: 700/100ma										
Medium: 600/80ma										
Low: 400/50ma										
= suggested values										

14 Feedback Control

14.1 Feedback System

Perrot Satellite can be equipped with bidirectional decoders instead of the standard ones (see chapter 13). Bidirectional decoders provide information to the user on whether a station equipped with them operates faultlessly.

A flow sensor, which can be installed in each valve or in each sprinkler is periodically asked whether the water flows or not.

Perrot Satellite then compares the planned and the real states.

Should a discrepancy be detected, an error message appears immediately.

If *Perrot Satellite* is equipped only with standard decoders, the signal is transferred in one direction only, i.e. from VCU to decoders.

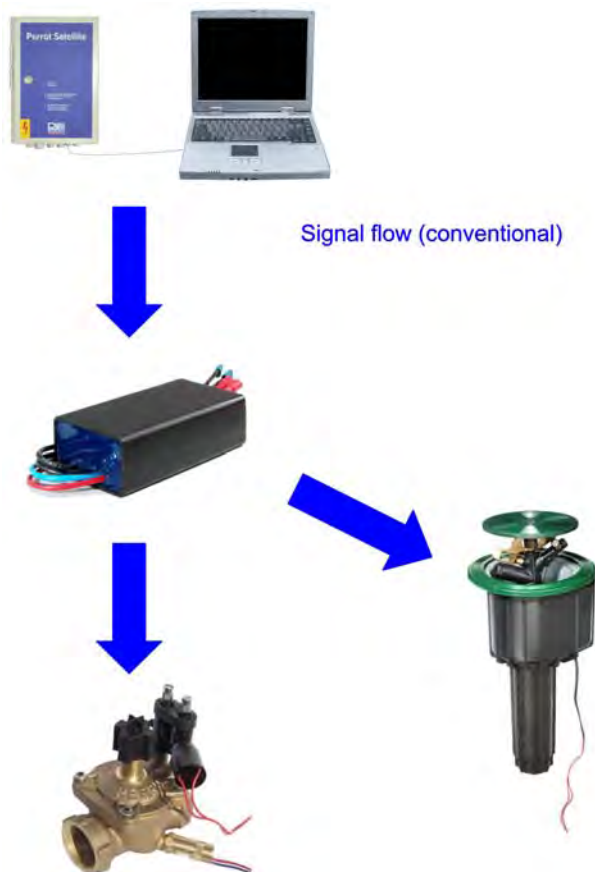

However, *Perrot Satellite* also supports bidirectional decoders. A bidirectional decoder communicates with a VCU in both directions. It can receive information and perform orders contained in them. In addition to these, a bidirectional decoder can send information on the irrigation station current state back to its VCU.

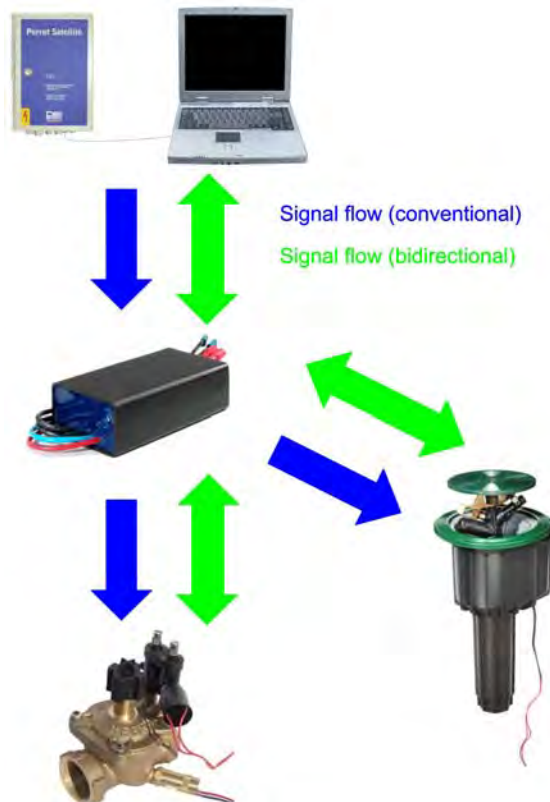

Any system can combine both standard and bidirectional decoders.

A bidirectional decoder and a flow sensor can read all the following states and send information about them back to *Perrot Satellite*:

- ✓ Valve is open
- ✓ Valve is closed
- ✓ Valve coil is short-circuited
- ✓ Connection to valve coil is broken
- ✓ Decoder does not answer
- ✓ Voltage on the decoder is too low

This information helps the user to recognise possible problems before they could lead to damaging part(s) of the equipment.

An error message, however, can appear even at times when the equipment is still running without problems. In such a case, it is proactive advance notification of a state in which a significant drop of the coil resistance has been detected – even though the coil is still operating perfectly and there is still a lot of time before it needs to be replaced. Please do pay attention to such messages. It will help you with later fault diagnosing.

You can set the

"If – Then" option

in *Perrot Satellite* to automatically interrupt the running irrigation program if a certain number of error messages is exceeded.

14.2 Setting up the Feedback System

14.2.1 Entering Data for Bidirectional Decoder and Pressure Sensor

The feedback system can only be set for bidirectional decoders. If you have a bidirectional decoder or a bidirectional decoder with pressure sensor installed in your system, their values are to be entered together with valve data (see chapter 5.8).

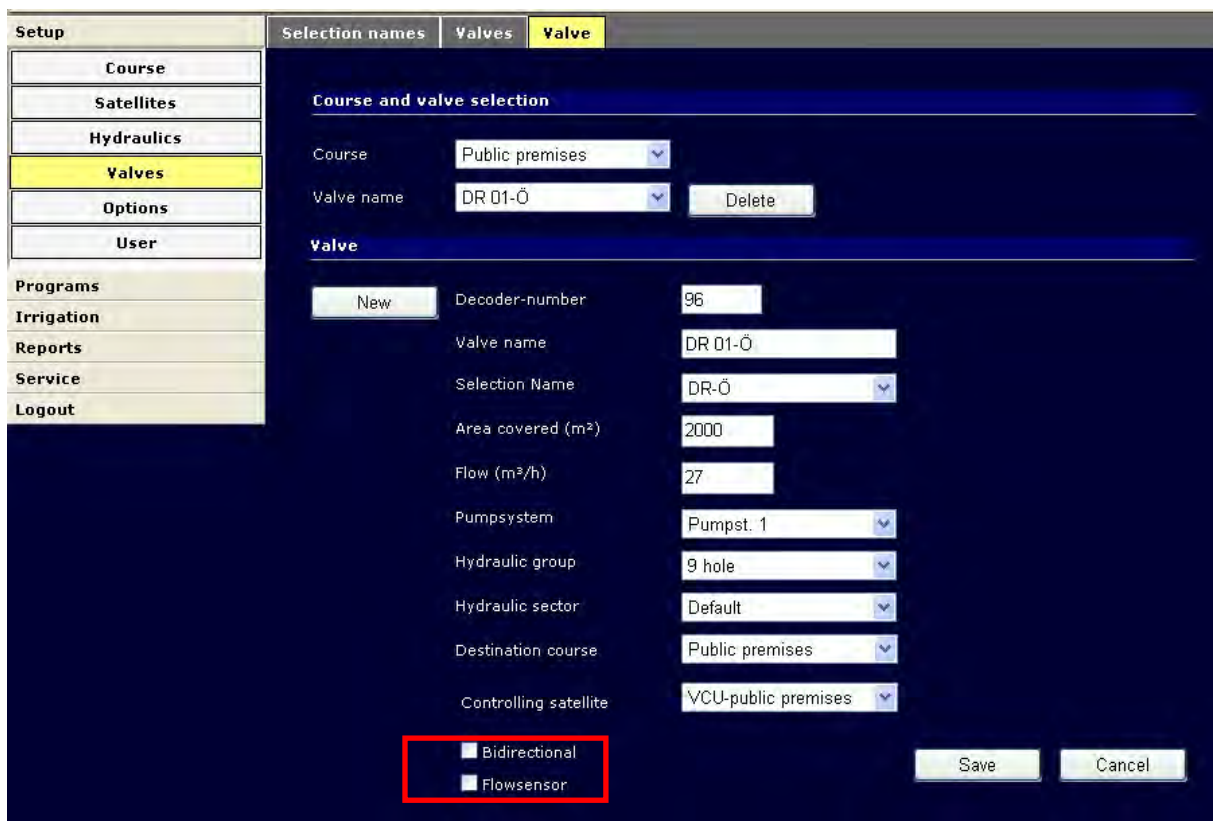

The screenshot shows the 'Valve' configuration window in the Perrot Satellite software. The window has a sidebar on the left with menu items: Setup, Course, Satellites, Hydraulics, Valves (highlighted), Options, User, Programs, Irrigation, Reports, Service, and Logout. The main area is titled 'Valve' and contains the following fields:

- Course and valve selection:** Course (Public premises), Valve name (DR 01-Ö), and a Delete button.
- Valve configuration:**
 - Decoder-number: 96
 - Valve name: DR 01-Ö
 - Selection Name: DR-Ö
 - Area covered (m²): 2000
 - Flow (m³/h): 27
 - Pumpsystem: Pumpst. 1
 - Hydraulic group: 9 hole
 - Hydraulic sector: Default
 - Destination course: Public premises
 - Controlling satellite: VCU-public premises
- Options:**
 - Bidirectional
 - Flowsensor
- Buttons: Save, Cancel

If you want to use a bidirectional decoder, the **Bidirectional** tickbox must be ticked. If you want to use a bidirectional decoder with a flow sensor, the **Flowsensor** tickbox must be ticked.

14.2.2 Setting up Feedback

In the main menu:

1.	Setup	Control
----	-------	---------

Options	<div style="display: flex; border-bottom: 1px solid black;"> <div style="width: 20%; border-right: 1px solid black; padding: 5px;"> <p>Setup</p> <p>Control</p> <p>Emergency call</p> </div> <div style="width: 80%; padding: 5px;"> <div style="display: flex; justify-content: space-between;"> <div style="width: 48%;"> <p>Feedback-decoder settings</p> <p>Max. no. of faulty opened valves permitted (0..255) <input style="width: 50px;" type="text" value="25"/></p> <p>Decoder open delay time (15-250 sec) <input style="width: 50px;" type="text" value="30"/></p> <p>Decoder close delay time (15-250 sec) <input style="width: 50px;" type="text" value="30"/></p> </div> <div style="width: 48%;"> <p>Feedback-decoder settings</p> <p>Test interval from (hh:mm) <input style="width: 60px;" type="text" value="00:00"/></p> <p>Test interval to (hh:mm) <input style="width: 60px;" type="text" value="00:00"/></p> <p style="text-align: right;"><input type="button" value="Set interval"/></p> </div> </div> <div style="margin-top: 10px;"> <p>Irrigation control</p> <p>Weather parameter timeout (min) <input style="width: 50px;" type="text" value="60"/></p> <p>Optimum sequence capacity limit (50-100%) <input style="width: 50px;" type="text" value="100"/></p> <p>Valve overlap/delay <input style="width: 50px;" type="text" value="0"/></p> <p>Valve overlap/delay manual programs <input style="width: 50px;" type="text" value="0"/></p> <p><input type="checkbox"/> Autostart irrigation mode</p> <p>Pump control</p> <p>Mean time used in calculating valve flow automatic (sec) <input style="width: 50px;" type="text" value="30"/></p> <p>Mean time used in calculating valve flow manual (sec) <input style="width: 50px;" type="text" value="30"/></p> <p style="text-align: right;"><input type="button" value="Save"/></p> </div> </div> </div>
---------	--

Max. No. of faulty opened valves permitted

If the number of the "valve open error" error messages exceeds the limit value specified in the **Max. No. of faulty opened valves permitted** field, the irrigation process interrupts. All active programs stop, all manually open valves close. The irrigation status changes into "Error".

Irrigation can only be resumed after the error is acknowledged in the **Service > Error handling** menu.

Acceptable values: 0- 255
Standard value: 0 (function not activated)

Decoder open delay time

This time specifies for how long the system will accept the "Valve closed" status before it sends an error message.

Acceptable values: 15 – 250 s
Standard value: 30 s

After you have entered the required value, click the **Save** button to accept the value.



It is recommended to set this time to 150 seconds to prevent the generation of false error messages.

Decoder close delay time

This time specifies for how long the system will accept the "Valve open" status before it sends an error message.

Acceptable values: 15 – 250 s
Standard value: 30 s

After you have entered the required value, click the **Save** button to accept the value.

"Feedback-decoder settings" Screen Section

The bidirectional decoder sends a short pulse (5 ms) to the coil approximately each 1 minute. These pulses test the coil resistance and the correct connection between the decoder and the coil.

Some valves, however, respond so quickly, that they briefly open even after such a short coil activation. To prevent this false valve opening at unwanted times, you have to set suitable testing times in the **Test interval from** and **Test interval to** fields.

Example :

From 01:30 to 03:00	1h 30 min. test duration
From 22:30 to 01:00	2h 30 min. test duration
From 00:00 to 00:00	function is inactive, no test
From 00:00 to 23:59	test duration around the clock



It is recommended to set the test interval to 60 minutes and to run the tests at night times.



The entered values must be saved by clicking the **Set interval** button!

14.3 Error Handling in Perrot Satellite Feedback System

Information sent by a bidirectional decoder back to the VCU can be displayed in the **Service > Satellite > Log** menu:

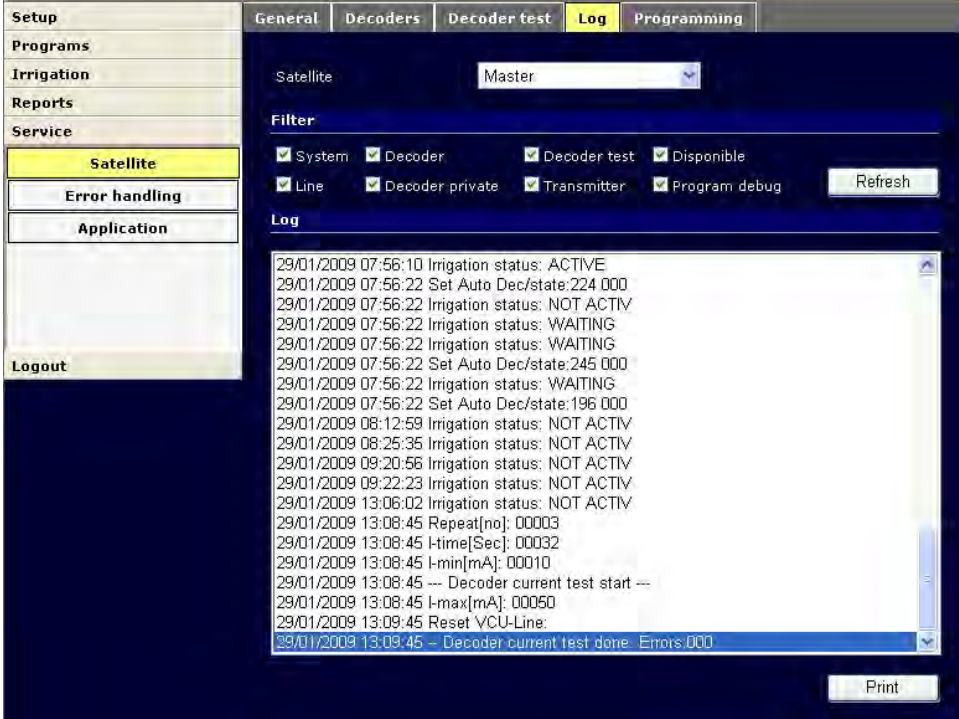
1.	Service	Log
<p style="text-align: center;">Satellite</p>		

Perrot Satellite checks whether this information corresponds with the programmed irrigation procedure. If it does not, it generates a **warning** message.

All warning messages generated can displayed in the following menu:

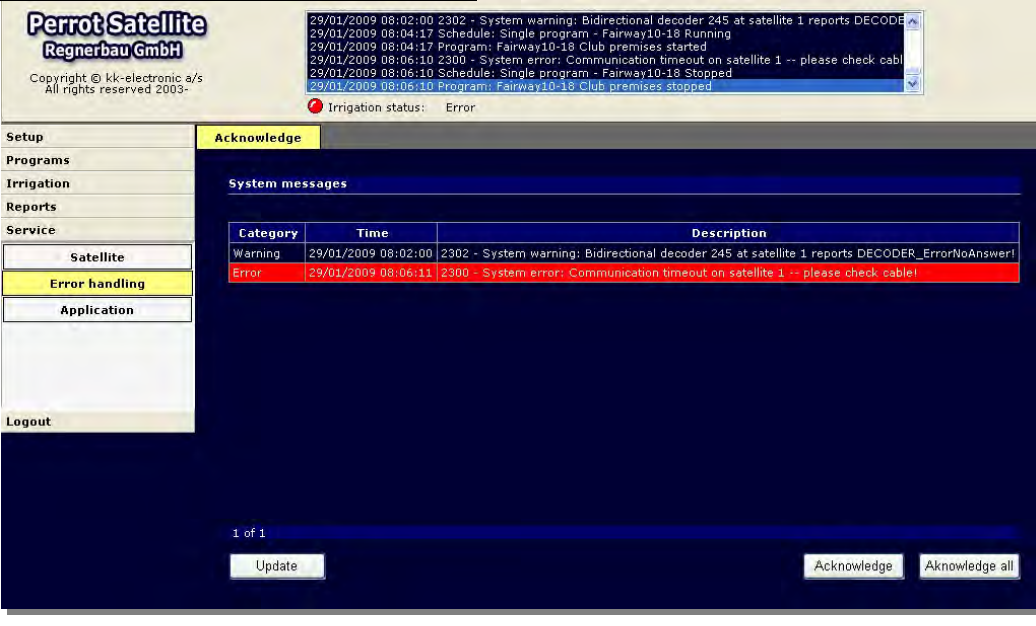
2.	Service	Acknowledge
<p style="text-align: center;">Error message</p>		

One of the following warning messages is then displayed, reflecting the state reported by the bidirectional decoder:

- ✓ Valve is open while decoder XX is closed
- ✓ Valve is closed while decoder XX is active
- ✓ Decoder XX reports short circuit at the valve coil
- ✓ Decoder XX reports no connection to the valve coil
- ✓ No answer on decoder XX
- ✓ Low voltage at decoder XX

These warning messages have no consequences, but rather just inform the user that there might be something out of order in the system. We recommend to monitor them closely and to track the fault if these repeat.

The following warning message is an exception:

"Valve is open while decoder XX is closed"

If this message appears three times in a row, *Perrot Satellite* generates an error message. In addition to this, if the number of these warning messages exceeds the number previously set in the

"Max. no. of faulty opened valves permitted" (see chapter 14.2.2)

field, irrigation is interrupted and "Error" appears in the irrigation status line. Other warning messages are not dangerous for the system and therefore do not interrupt the irrigation process.



These messages are displayed in red in the **Service > Error handling** menu.

To reset the warning/error message, click the **Acknowledge all** button, which also restarts (initialises) the VCU.

15 Service Menu

15.1 Overview of Measured Values

The **Service > Satellite > General** screen presents all electric current values as metered by the VCU. The displayed values are raw, i.e. not recalculated with scale and/or offset values.

1.	Service	General
	Satellite	

2.	Satellite	↓	Choose the satellite, from which you want to display the metered values.
----	-----------	---	--

Description of fields/values:

Analog 1-4: Value in mA at the analog inputs 1 – 4 (S5-S8)

Frequency 1-2: Frequency in Hz (S9+S10)

Earth radiance: Leakage current from the decoder cables
The earth-leaking current must not exceed the following values:
0.7 A for 8 sec
1.0 A for 4 sec
1.4 A for 2 sec
2.0 A for 1 sec

Net consumption:	Current flow through decoder cables [A] The current consumption is too high. Values must not exceed: 2.8 A for 32 sec 4.0 A for 16 sec The optimum consumption (draw from the mains) can be calculated as the VCU consumption (50 mA) plus the consumption of all decoders (1 mA each). <u>Example:</u> A system with 100 decoders should have a standby consumption of 150 mA.
Digital 1:	Relay output 1 active/inactive
Digital 2:	Relay output 2 active/inactive
Out A (V):	Output voltage [V] on decoder cables A
Out B (V):	Output voltage [V] on decoder cables B Voltage lower than the limit value: Less than 20.0 V for 32 s
Digital 1-2:	Status of the digital inputs 1 - 2
<u>LED 1 (yellow):</u>	<u>Irrigation program status</u>
ON:	Irrigation program is running.
BLINKING:	Irrigation program interrupted by a weather station.
SHORT BLINKS:	Running program has been interrupted.
LONG BLINKS:	VCU is in waiting mode.
OFF:	VCU error
<u>LED 2 (red):</u>	<u>Status of the 2-wire cable</u>
ON:	2-wire cable error (see the VCU status)
BLINKING:	No error or the earth radiance value is greater than 0.25 A. Operation continues.
SHORT BLINKS:	2-wire cable connected, preparing to connect to decoders.
OFF:	Correct status, no error.

15.2 Decoder Test

You can perform a passive decoder test in the **Service > Satellite > Decoder test** menu.

This test gives just quantitative information about the decoder functioning. Possible problems/faults must be physically checked at their places.

Approximately one minute after a test start, the system starts metering the current flowing through the decoder cables.

This metered current then serves as the reference value.

The first decoder is activated for the time set as the testing interval.

During the test, the current on the decoder cables is regularly metered. A mean value is then calculated from these metered values.

The reference value is deducted from this mean value.

The result is the decoder power drain (consumption).

All the other decoders are tested the same way.



If the decoder and the coil are in order, their power drain is between 10 and 50 mA. Should lower or higher values be metered, we recommend physically checking the decoder.



If values (higher or lower) outside the acceptable tolerance are metered, the metering process repeats two times. This may significantly prolong the whole testing process.

In the main menu: go to the Decoder Test:

1.	Service	Decoder Test
----	---------	--------------

- Setup
- Programs
- Irrigation
- Reports
- Service
- Satellite
- Error handling
- Application
- Logout

General
Decoders
Decoder test
Log
Programming

Satellite Master

1	2	3	4	5	6	7	8	9	10
11	12	13	14	15	16	17	18	19	20
21	22	23	24	25	26	27	28	29	30
31	32	33	34	35	36	37	38	39	40
41	42	43	44	45	46	47	48	49	50
51	52	53	54	55	56	57	58	59	60
61	62	63	64	65	66	67	68	69	70
71	72	73	74	75	76	77	78	79	80
81	82	83	84	85	86	87	88	89	90
91	92	93	94	95	96	97	98	99	100
101	102	103	104	105	106	107	108	109	110
111	112	113	114	115	116	117	118	119	120
121	122	123	124	125	126	127	128	129	130
131	132	133	134	135	136	137	138	139	140
141	142	143	144	145	146	147	148	149	150
151	152	153	154	155	156	157	158	159	160
161	162	163	164	165	166	167	168	169	170
171	172	173	174	175	176	177	178	179	180
181	182	183	184	185	186	187	188	189	190
191	192	193	194	195	196	197	198	199	200
201	202	203	204	205	206	207	208	209	210
211	212	213	214	215	216	217	218	219	220
221	222	223	224	225	226	227	228	229	230
231	232	233	234	235	236	237	238	239	240
241	242	243	244	245	246	247	248	249	250
251	252	253	254	255					

● Not installed
● Opening
● Open
● Closing
● Closed

Averaging (sec.)

Perrot Satellite ENG win7

State as of 03.04.2019

Page 173 / 180

Performing Decoder Tests

1. You can select the decoder to test in three different ways:
 - A) Click the **All** button. This will test all decoders.
 - B) Click the **Installed** button. This will test only decoders marked with the red point.
 - C) Tick the tick-boxes of the required decoders.



You can cancel your selection by clicking the **None** button.

2. Choose the testing time in seconds: Open the **Averaging (sec.)** combo-box and choose one of the available times. The longer the testing time, the more accurate the metered values.
3. Start the test by clicking the **Test** button.



Do not leave the screen until the test is complete.



The LED on the VCU keeps blinking during the test.



During the decoder test, the pump decoder does not start, but the valves physically do open. Please shut the main feeding valve off if you do not want the valves to leak water.

Test Results

The current draw (consumption) of individual decoders displays in the **Service > Satellite > Log** menu:

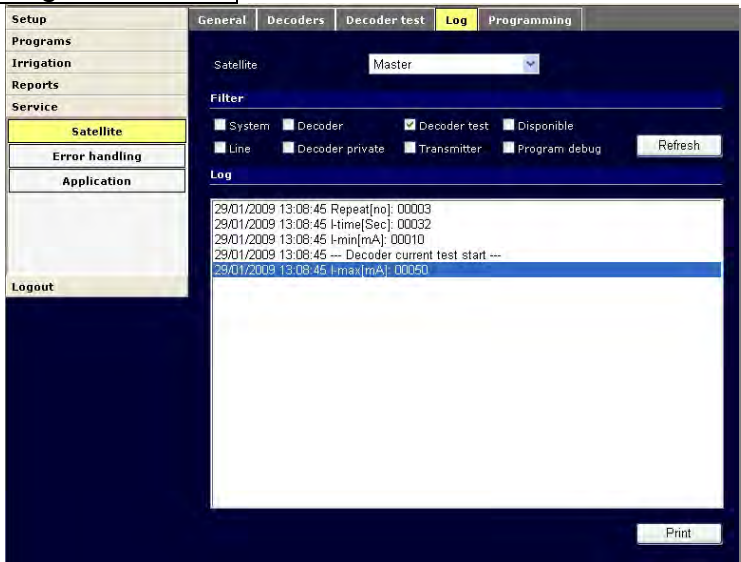
1.	Service	Log
	Satellite	 <p>The screenshot shows the software interface with the 'Log' menu selected. The 'Log' window displays the following text:</p> <pre> 29/01/2009 13:08:45 Repeat[no]: 00003 29/01/2009 13:08:45 Htime[Sec]: 00032 29/01/2009 13:08:45 Imin[mA]: 00010 29/01/2009 13:08:45 -- Decoder current test start -- 29/01/2009 13:08:45 Imax[mA]: 00050 </pre>

1. Choose the required satellite (VCU) in the **Satellite** combo-box.
2. Set the filter section to have only the **Decoder Test** tickbox ticked.
3. Click the **Refresh** button. This will display only the decoder test results.



If one or more of the displayed values are out of tolerance, the line is marked with an asterisk (*). If this results does not change even after an additional two measurements, this decoder will be marked with "ERROR".

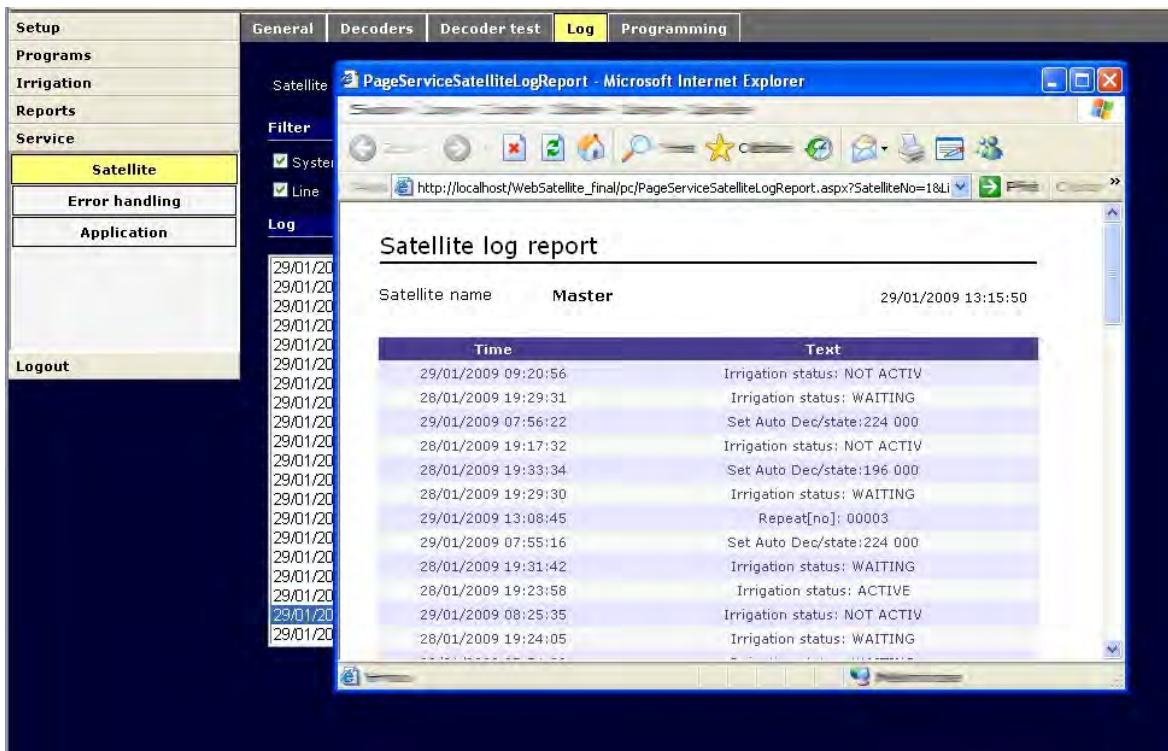

The screenshot shows a web browser window titled 'PageServiceSatellitelogReport - Microsoft Internet Explorer'. The browser address bar shows 'http://localhost/WebSatellite_final/pc/PageServiceSatellitelogReport.aspx?SatelliteNo=1&Li'. The main content area displays a 'Satellite log report' for a 'Master' satellite on 29/01/2009 at 13:15:50. The log contains the following entries:

Time	Text
29/01/2009 09:20:56	Irrigation status: NOT ACTIV
28/01/2009 19:29:31	Irrigation status: WAITING
29/01/2009 07:56:22	Set Auto Dec/state:224 000
28/01/2009 19:17:32	Irrigation status: NOT ACTIV
29/01/2009 19:33:34	Set Auto Dec/state:196 000
28/01/2009 19:29:30	Irrigation status: WAITING
29/01/2009 13:08:45	Repeat[no]: 00003
29/01/2009 07:55:16	Set Auto Dec/state:224 000
28/01/2009 19:31:42	Irrigation status: WAITING
28/01/2009 19:23:58	Irrigation status: ACTIVE
29/01/2009 08:25:35	Irrigation status: NOT ACTIV
28/01/2009 19:24:05	Irrigation status: WAITING

The print preview displays the total number of decoders with out-of-tolerance values at the end of the list.

The range of decoder current should be between 10 - 50 mA.



Note: If a short circuit occurs on the decoder cables, the test results are unreliable!

15.3 Viewing the Application Log

1.	Service	Log
	Application	

The screen lists all events generated by the system control. This list is identical with the system report log displayed in the box in the header of all *Perrot Satellite* screens. This list, however, saves the events for a longer time and the events can be printed out at any time.

16 Error Codes

Incorrect values entered or system problems may cause errors. These are written in red on the corresponding screen or can be listed on the **Service > Error handling** screen.

Each error as its own ID number (code). Please specify this error ID number each time you contact the hotline.

The screenshot shows the 'Valve' configuration screen. The sidebar menu on the left has 'Valves' highlighted. The main area is titled 'Course and valve selection' and contains the following fields and options:

- Course: Club premises (dropdown)
- Valve name: (empty field) [Delete]
- Valve section header
- New button
- Decoder-number: 175
- Valve name: FW 01-1
- Selection Name: FW 01-09 (dropdown)
- Area covered (m²): 666
- Flow (m³/h): 27
- Pumpsystem: Pumpst. 1 (dropdown)
- Hydraulic group: A (dropdown)
- Hydraulic sector: Default (dropdown)
- Destination course: Club premises (dropdown)
- Controlling satellite: Master (dropdown)
- Bidirectional
- Flowsensor
- [Save] [Cancel]

An error message '1601 - Decoder '175' already used!' is displayed in red text at the bottom left, circled in red. A yellow arrow points to this message.

Error codes are listed in the following table:

Error ID No.	Description
1000	Internal error: {0}
1100	Pumpsystem flow is lower than hydraulic group flow for hydraulic group {0}
1101	Pumpsystem '{0}' already exists!
1102	Empty pumpsystem name!
1103	Pumpsystem does not exist!
1104	Total pumpsystem flow is lower than current minimum hydraulic group flow!
1105	Pump does not exist!
1106	Pump '{0}' already exists!
1107	Empty pump name!
1108	Satellite must be chosen!
1109	Pump activated not allowed to edit
1110	Resulting flow for pumpsystem would be smaller than flow for valve '{0}' ({1} m ³ /h)!
1111	Pumpsystem is used by programs, not allowed to delete
1112	Pump is used by programs, not allowed to delete, Hydraulic group flow exceeds pumpsystem
1200	Hydraulic group flow exceeds pumpsystem capacity ({0} m ³ /h)!
1201	Hydraulic group '{0}' already exists!
1202	Empty hydraulic group name!
1203	Hydraulic group does not exist!
1204	Empty hydraulic group name!
1300	Empty hydraulic sector name!
1301	Hydraulic sector does not exist!
1302	Hydraulic sector '{0}' already exists!
1303	Hydraulic sector flow exceeds group capacity ({0} m ³ /h)!
1304	Hydraulic sector flow constraint violation!
1305	Resulting flow for sector would be smaller than flow for valve '{0}' ({1}m ³ /h)!
1400	Empty valve name!
1401	Valve named '{0}' already exists!
1402	Valve named '{0}' does not exist!
1403	Unable to delete valve in use by a valve collection!
1404	Density must be between 0 and 999 mm
1405	Density causes time to exceed max limit (479 min)
1406	Time must be between 0 and 479 min
1407	Time causes density to exceed max limit (999 min)
1408	Consumption exceeds sector limit ({0} m ³ /h)
1409	No valve found!
1410	No valve data present
1500	Decoder number must be between 1 and 255!
1501	Decoder '{0}' already exists!
1600	Course name '{0}' already exists!
1601	Course name is not allowed to be empty!
1602	Unable to delete non-empty course
1602	Unable to delete course

Error ID No.	Description
1700	Satellite {0} number {1} already exists!
1701	Enter name for Satellite
1702	Invalid satellite no!
1703	Internal error: Satellite does not exist!
1704	Unable to delete satellite - has decoders connected
1800	Valve collection '{0}' already exists!
1801	Empty valve collection name!
1802	Empty valve name!
1803	Unable to delete non-empty valve collection: {0}!
1804	Internal error: Valve collection does not exist!
1805	Invalid course '{0}' specified for valve collection!
1806	Invalid valve '{0}' specified for valve collection!
1807	Valve '{0}' in collection '{1}' exceeds time limit (479 min)
1808	Valve '{0}' in collection '{1}' exceeds sector limit ({2} m ³ /h)
1900	Empty program name!
1901	Program '{0}' already exists!
1902	Unable to delete program in use '{0}'!
1903	Program contains no program lines!
1904	Unable to delete step 1. Manual programs consists of at least one step!
1905	Number of valves in step exceeds maximum {0}!
2000	Unknown user '{0}'
2001	User name '{0}' already exists!
2002	Invalid password
2003	Invalid privilege
2100	Invalid filename
2100	Exception: '{0}'
2201	Schedule not valid
2202	Invalid schedule name
2203	Schedule item not valid!
2204	A schedule is running
2205	Tries to use occupied pumpsystem
2206	Schedule named '{0}' already exists
2207	Schedule name can not be empty
2208	Selected course not valid
2209	Selected program not valid
2300	System error: Communication timeout on satellite {0} -- please check cable!
2301	System warning: Bidirectional decoder {0} at satellite {1} reports flow while closed!
2302	System warning: Bidirectional decoder {0} at satellite {1} reports {2}!
2303	System error: Number of bidirectional decoders at satellite {0} exceeds limit!
2304	System error: Satellite {0} reported line errors!
2305	Weatherstation: Rain on opener at satellite {0}!
2306	Weatherstation: Rain on closer at satellite {0}!
2307	System error: Measured flow at pumpsystem {0} exceeds threshold ({1:0.0})!
2308	System error: Measured pressure at pumpsystem {0} exceeds threshold ({1:0.0})!

Error ID No.	Description
2309	System error: Measured wind speed at satellite {0} exceeds threshold ({1:0.0})!
2310	System error: Measured XY value at satellite {0} exceeds threshold ({1:0.0})!
2311	System error: Measured frequency 1 value at satellite {0} exceeds threshold ({1:0})!
2312	System error: Measured frequency 2 value at satellite {0} exceeds threshold ({1:0})!
2313	System error: Irrigation stopped --- Irrigation error timeout !
2314	System warning: Bidirectional decoder {0} at satellite {1} reports no flow while open!
2315	System error: Error on either opener (S3) or closer (S4) prevents irrigation!
2401	Hydraulic group flow is lower than hydraulic sector flow for hydraulic sector: {0}
2402	Flow capacity is to low
2403	DataSlinger version of SVG document not correct
2404	SVG conversion failed
2405	SVG file is not valid
2406	Max {0} is allowed for 'Valve overlap/delay'
2407	Min {0} is allowed for 'Valve overlap/delay'
2408	Max {0} is allowed for 'Valve overlap/delay manual programs'
2409	Min {0} is allowed for 'Valve overlap/delay manual programs'
2410	Time not valid
2411	Mean time used for calculating automatic valve flow must be greater than or equal to {0} secs!
2412	Mean time used for calculating manual valve flow must be greater than or equal to {0} secs!

Warning ID	Description
Z. 313	Warning
Z. 446	Warning: Irrigation parameter {0} exceeds threshold ({1:0.0})
Z. 447	Warning: Programs using pump in service

We remain at your full disposal for any further information you may require!

REGNERBAU CALW GmbH
Industriestrasse 19-29
75382 Althengstett / Germany
Tel. +49 / 7051 / 162-0
technik@perrot.de
http://www.perrot.de

